

**Agilent U1211A, U1212A,
and U1213A
Clamp Meters**

User's and Service Guide



Agilent Technologies

Notices

© Agilent Technologies, Inc., 2009–2013

No part of this manual may be reproduced in any form or by any means (including electronic storage and retrieval or translation into a foreign language) without prior agreement and written consent from Agilent Technologies, Inc. as governed by United States and international copyright laws.

Manual Part Number

U1211-90001

Edition

Eighth Edition, May 23, 2013

Agilent Technologies, Inc.
5301 Stevens Creek Blvd.
Santa Clara, CA 95051 USA

Trademark Acknowledgements

Pentium is a U.S. registered trademark of Intel Corporation.

Microsoft, Visual Studio, Windows, and MS Windows are trademarks of Microsoft Corporation in the United States and or other countries.

Warranty

The material contained in this document is provided “as is,” and is subject to change, without notice, in future editions. Further, to the maximum extent permitted by the applicable law, Agilent disclaims all warranties, either express or implied, with regard to this manual and any information contained herein, including but not limited to the implied warranties of merchantability and fitness for a particular purpose. Agilent shall not be liable for errors or for incidental or consequential damages in connection with the furnishing, use, or performance of this document or of any information contained herein. Should Agilent and the user have a separate written agreement with warranty terms covering the material in this document that conflict with these terms, the warranty terms in the separate agreement shall control.

Technology Licenses

The hardware and or software described in this document are furnished under a license and may be used or copied only in accordance with the terms of such license.

Restricted Rights Legend

U.S. Government Restricted Rights. Software and technical data rights granted to the federal government include only those rights customarily provided to end user customers. Agilent provides this customary commercial license in Software and technical data pursuant to FAR 12.211 (Technical Data) and 12.212 (Computer Software) and, for the Department of Defense, DFARS 252.227-7015 (Technical Data - Commercial Items) and DFARS 227.7202-3 (Rights in Commercial Computer Software or Computer Software Documentation).

Safety Notices

CAUTION







A **CAUTION** notice denotes a hazard. It calls attention to an operating procedure, practice, or the likes of that, if not correctly performed or adhered to, could result in damage to the product or loss of important data. Do not proceed beyond a **CAUTION** notice until the indicated conditions are fully understood and met.

WARNING

A **WARNING** notice denotes a hazard. It calls attention to an operating procedure, practice, or the likes of that, if not correctly performed or adhered to, could result in personal injury or death. Do not proceed beyond a **WARNING** notice until the indicated conditions are fully understood and met.

Safety Symbols

The following symbols on the instrument and in the documentation indicate precautions which must be taken to maintain safe operation of the instrument.

	Direct current (DC)		Caution, risk of electric shock
	Alternating current (AC)		Caution, risk of danger (refer to this manual for specific Warning or Caution information)
	Earth (ground) terminal		Equipment protected throughout by double insulation or reinforced insulation
CAT III 1000 V	Category III 1000 V overvoltage protection		Application around and removal from HAZARDOUS LIVE conductors is permitted
CAT IV 600 V	Category IV 600 V overvoltage protection		

General Safety Information

WARNING

- When working above 30 V_{AC} RMS or 60 V_{DC}, exercise caution – such range poses a shock hazard.
- Do not measure more than the rated current and voltage (as marked on the clamp meter).
- Ensure the test leads are disconnected from the input terminals when measuring current with the clamp meter. Keep your fingers behind the hand guard when performing measurements.
- When connecting probes, always connect the common test probe first. When disconnecting probes, always disconnect the live test probe first.
- Detach test probes from the clamp meter before you open the battery cover.
- Do not use the clamp meter with the battery cover or part of the cover removed or loose.
- Replace the battery as soon as the low battery indicator is shown on the annunciator display. This is to avoid false readings, which may lead to possible electric shock or personal injury.
- When measuring temperature, keep the thermocouple probe as close to the meter as possible, and avoid contact with surface above 30 V_{AC} RMS or 60 V_{DC} as this will pose shock hazard.
- Do not operate the product in an explosive atmosphere or in the presence of flammable gases or fumes.
- Inspect the case for cracks or missing plastic. Pay extra attention to the insulation surrounding the connectors. Do not use the clamp meter if it is damaged.
- Inspect the test probes for damaged insulation or exposed metal, and check for continuity. Do not use the test probe if it is damaged.
- Do not service or perform adjustments alone. Under certain condition, hazardous voltages may exist, even with the equipment switched off. To avoid dangerous electric shock, service personnel must not attempt internal service or adjustment unless another person, capable of rendering resuscitation or first aid, is present.

WARNING

- **Do not substitute parts or modify equipment to avoid the danger of introducing additional hazards. Return the product to the nearest Agilent Technologies Sales and Service office for service and repair to ensure the safety features are maintained.**
 - **Do not operate damaged equipment as the safety protection features built into this product may have been impaired, either through physical damage, excessive moisture, or any other reason. Remove power and do not use the product until safe operation can be verified by service-trained personnel. If necessary, return the product to the nearest Agilent Technologies Sales and Service office for service and repair to ensure the safety features are maintained.**
-

CAUTION

- Turn off circuit power and discharge all high-voltage capacitors in the circuit before you perform resistance and capacitance measurements or continuity and diode tests.
 - Use the correct terminals, function, and range for your measurements.
 - Never measure voltage when current measurement is selected.
 - Use only the recommended battery type. Ensure proper insertion of battery in the clamp meter, and follow the correct polarity.
-





Use the clamp meter only as specified in this guide. Otherwise, the protection provided by the clamp meter may be impaired.

Environmental Conditions

This instrument is designed for indoor use and in an area with low condensation. The table below shows the general environmental requirements for this instrument.

Environmental conditions	Requirements
Operating temperature	–10 °C to 50 °C
Relative humidity	Maximum 80% RH for temperature up to 31 °C decreasing linearly to 50% RH at 50 °C
Altitude (operating)	2000 meters
Storage temperature	–20 °C to 60 °C
Storage humidity	0% to 80% RH non-condensing

Regulatory Markings

	<p>The CE mark is a registered trademark of the European Community. This CE mark shows that the product complies with all the relevant European Legal Directives.</p>		<p>The C-tick mark is a registered trademark of the Spectrum Management Agency of Australia. This signifies compliance with the Australia EMC Framework regulations under the terms of the Radio Communication Act of 1992.</p>
	<p>The CSA mark is a registered trademark of the Canadian Standards Association.</p>		<p>This symbol indicates the time period during which no hazardous or toxic substance elements are expected to leak or deteriorate during normal use. Forty years is the expected useful life of the product.</p>
<p>ICES/NMB-001</p>	<p>ICES/NMB-001 indicates that this ISM device complies with the Canadian ICES-001. Cet appareil ISM est conforme a la norme NMB-001 du Canada.</p>		<p>This instrument complies with the WEEE Directive (2002/96/EC) marking requirement. This affixed product label indicates that you must not discard this electrical or electronic product in domestic household waste.</p>

Waste Electrical and Electronic Equipment (WEEE) Directive 2002/96/EC

This instrument complies with the WEEE Directive (2002/96/EC) marking requirement. This affixed product label indicates that you must not discard this electrical or electronic product in domestic household waste.

Product Category:

With reference to the equipment types in the WEEE directive Annex 1, this instrument is classified as a “Monitoring and Control Instrument” product.

The affixed product label is as shown below.



Do not dispose in domestic household waste

To return this unwanted instrument, contact your nearest Agilent Service Centre, or visit:

www.agilent.com/environment/product

for more information.

Declaration of Conformity (DoC)

The Declaration of Conformity (DoC) for this instrument is available on the Web site. You can search the DoC by its product model or description.

<http://regulations.corporate.agilent.com/DoC/search.htm>

NOTE

If you are unable to search for the respective DoC, please contact your local Agilent representative.

THIS PAGE HAS BEEN INTENTIONALLY LEFT BLANK.

Table of Contents

1 Getting Started

Introduction	20
Features	21
Initial Inspection	22
Standard purchase items	22
Product at a glance	23
The front panel at a glance	23
The annunciator display at a glance	24
The buttons at a glance	27
The rotary switch at a glance	30
The terminals at a glance	31
The clamp jaw at a glance	32
The rear panel at a glance	33

2 Making Measurements

Performing Current Measurement	36
Performing Voltage Measurement	38
Performing Resistance Measurement and Continuity Test	40
Performing Diode Measurement	43
Performing Capacitance Measurement	46
Performing Temperature Measurement	48

3 Functions and Features

Data Hold (Trigger Hold)	52
Enabling the data hold function	52
Refresh Hold	54
Enabling the refresh hold function	54

Table of Contents

Dynamic Recording	56
Enabling the dynamic recording mode	56
1 ms Peak Hold	59
Enabling the 1 ms peak hold function	59
Null (Relative)	61
Enabling the null operation	61
4 Changing the Default Settings	
Selecting Setup Menu	64
Default Factory Settings and Available Setting Options	66
Setting minimum frequency measurement	68
Setting beep frequency	69
Setting Data Hold/Refresh Hold mode	70
Setting auto power-off mode	71
Setting backlight power-on duration	72
Setting temperature unit	72
Returning to default factory settings	75
5 Maintenance	
General Maintenance	78
Battery replacement	79
Troubleshooting	81
Replacement Parts	82
To order replacement parts	82
6 Performance Tests and Calibration	
Calibration Overview	84
Closed-case electronic calibration	84
Agilent Technologies calibration services	84
Calibration Interval	84

Adjustment recommendation	85
Recommended Test Equipment	86
Basic Operating Tests	87
Testing the display	87
Testing the backlight	87
Test Considerations	88
Input connections	89
Performance Verification Tests	90
Functional tests (only for U1212A and U1213A)	95
Calibration Security	98
Unsecuring the instrument for calibration	98
Adjustment Considerations	101
Valid adjustment reference input values	102
Front Panel Calibration	107
Calibration process	107
Adjustment procedures	107
Adjustment count	115
Error Codes	117

7 Characteristics and Specifications

Product Characteristics	120
U1211A Electrical Specifications	122
DC specifications	122
AC specifications	123
Voltage 1 ms peak hold specifications	124
Current 1 ms peak hold specifications	124
Frequency specifications	125
Operating specifications	126
U1212A Electrical Specifications	127

Table of Contents

DC specifications	127
AC specifications	129
Voltage 1 ms peak hold specifications	130
Current 1 ms peak hold specifications	130
Temperature specifications	131
Frequency specifications	132
Operations specifications	133
U1213A Electrical Specifications	134
DC specifications	134
AC specifications	136
AC + DC specifications	137
Voltage 1 ms peak hold specifications	138
Current 1 ms peak hold specifications	138
Temperature specifications	139
Frequency specifications	140
Duty cycle	141
Operations specifications	141

List of Figures

Figure 1-1	Agilent U1211A, U1212A, and U1213A Clamp Meters	20
Figure 1-2	Clamp meter front panel	23
Figure 1-3	LCD annunciator display with full segments displayed	24
Figure 1-4	Hold/Max Min button	27
Figure 1-5	Function and status buttons	28
Figure 1-6	Clamp meter rotary switch	30
Figure 1-7	Clamp meter terminal inputs	31
Figure 1-8	Clamp jaw close and open state	32
Figure 1-9	Clamp meter rear panel	33
Figure 2-1	Measuring current	37
Figure 2-2	Measuring voltage	39
Figure 2-3	Measuring resistance	41
Figure 2-4	Continuity test	42
Figure 2-5	Measuring diode (forward bias)	44
Figure 2-6	Measuring diode (reverse bias)	45
Figure 2-7	Measuring capacitance	47
Figure 2-8	Measuring temperature	49
Figure 3-1	Data hold operation	53
Figure 3-2	Refresh hold operation	55
Figure 3-3	Dynamic recording mode	58
Figure 3-4	1 ms peak hold mode operation	60
Figure 3-5	Null (relative) mode operation	62
Figure 4-1	Setting the minimum frequency	68
Figure 4-2	Setting the beep frequency	69
Figure 4-3	Setting the data hold or refresh hold mode	70
Figure 4-4	Setting the auto power-off duration	72
Figure 4-5	Setting the backlight power-on duration	72
Figure 4-6	Setting the temperature unit	74
Figure 4-7	Reverting to default factory settings	75
Figure 5-1	Replacing the battery in the clamp meter	80
Figure 6-1	Full segments of annunciator display	87
Figure 6-2	Current performance verification test setup	94
Figure 6-3	Typical adjustment process flow	109
Figure 6-4	Displaying adjustment counts	116

List of Figures

List of Tables

Table 1-1	U1211A, U1212A, and U1213A annunciator display	24
Table 1-2	Analog bar-graph ranges	26
Table 1-3	Hold/Max Min button description	27
Table 1-4	Terminal connections for different measurement functions	31
Table 4-1	Setup mode buttons operation	64
Table 4-2	Default factory settings and available setting options for each feature	66
Table 5-1	Basic troubleshooting procedures	81
Table 5-2	Replacement parts list	82
Table 6-1	Recommended test equipment	86
Table 6-2	Performance verification tests	91
Table 6-2	Performance verification tests (continued)	93
Table 6-3	DC current offset verification test	95
Table 6-4	AC current balancing verification test	97
Table 6-5	U1211A valid adjustment reference input values	102
Table 6-6	U1212A valid adjustment reference input values	103
Table 6-7	U1213A valid adjustment reference input values	104
Table 6-8	U1211A list of adjustment items	110
Table 6-9	U1212A list of adjustment items	111
Table 6-10	U1213A list of adjustment items	113
Table 6-11	Error codes and their respective meanings	117
Table 7-1	Product characteristics	120
Table 7-2	U1211A DC accuracy \pm (% of reading + number of LSD)	122
Table 7-3	U1211A AC accuracy \pm (% of reading + number of LSD)	123
Table 7-4	U1211A voltage 1 ms peak hold specifications	124
Table 7-5	U1211A current 1ms peak hold specifications	124
Table 7-6	U1211A frequency accuracy specifications \pm (% of reading + number of LSD)	125
Table 7-7	U1211A frequency sensitivity during voltage and current measurement	125
Table 7-8	U1211A measuring rate	126
Table 7-9	U1212A DC accuracy \pm (% of reading + number of LSD)	127
Table 7-10	U1212A AC accuracy \pm (% of reading + number of LSD)	129
Table 7-11	U1212A voltage 1 ms peak hold specifications	130
Table 7-12	U1212A current 1 ms peak hold specifications	130

List of Tables

Table 7-13	U1212A temperature specifications	131
Table 7-14	U1212A frequency accuracy specifications \pm (% of reading + number of LSD)	132
Table 7-15	U1212A frequency sensitivity during voltage and current measurement	132
Table 7-16	U1212A measuring rate	133
Table 7-17	U1213A DC accuracy \pm (% of reading + number of LSD)	134
Table 7-18	U1213A AC accuracy \pm (% of reading + number of LSD)	136
Table 7-19	U1213A AC + DC voltage accuracy \pm (% of reading + number of LSD)	137
Table 7-20	U1213A AC + DC current accuracy \pm (% of reading + number of LSD)	137
Table 7-21	U1213A voltage 1 ms peak hold specifications	138
Table 7-22	U1213A current 1 ms peak hold specifications	138
Table 7-23	U1213A temperature specifications	139
Table 7-24	U1213A frequency accuracy specifications \pm (% of reading + number of LSD)	140
Table 7-25	U1213A frequency sensitivity during voltage and current measurement	140
Table 7-26	U1213A duty cycle accuracy specification	141
Table 7-27	U1213A measuring rate	141



1 Getting Started

Introduction	20
Features	21
Initial Inspection	22
Standard purchase items	22
Product at a glance	23
The front panel at a glance	23
The annunciator display at a glance	24
The buttons at a glance	27
The rotary switch at a glance	30
The terminals at a glance	31
The clamp jaw at a glance	32
The rear panel at a glance	33

This chapter contains a brief introduction and description of the front panel, display, buttons, and terminals on the Agilent U1211A, U1212A, and U1213A Clamp Meters.



Introduction

The Agilent U1211A, U1212A, and U1213A Clamp Meters are true RMS handheld clamp meters that enables you to measure harmonic currents accurately. Besides measuring current, the clamp meters are combined with built-in multimeter measurement features to enable other measurements associated to a multimeter.

All the clamp meter models are able to measure AC current, AC and DC voltage, resistance, audible continuity, diode, capacitance, and frequency. The U1212A has additional DC current and temperature measurement functions. The U1213A has additional AC + DC current, AC + DC voltage, and duty cycle tests apart from the additional measurement features from the U1212A.



Figure 1-1 Agilent U1211A, U1212A, and U1213A Clamp Meters

Features

The key features of Agilent U1211A, U1212A, and U1213A Clamp Meters are:

- AC, DC, and AC+DC (for U1213A only) voltage and current measurements.
- True RMS measurement for both AC voltage (ACV) and AC current (ACA).
- Orange LED backlight.
- Resistance measurement up to 40 M Ω (for U1213A only).
- Capacitance measurement up to 4000 μ F.
- Frequency measurement up to 200 kHz.
- 1 ms peak hold to capture in-rush voltage and current easily.
- Diode and audible continuity tests.
- K-type thermocouple for temperature measurement.
- Frequency and duty cycle measurements.
- Dynamic recording for min, max, and average readings.
- Data hold with manual trigger and null mode.
- Hand guard to prevent contact with conductors.
- Closed case calibration (except for U1212A and U1213A where open case calibration is needed for balance adjustment).

Initial Inspection

When you first receive your instrument, inspect the unit for any obvious damage such as broken terminals or cracks, dents, and scratches on the casing that may occur during shipment.

If any damage is found, notify the nearest Agilent Sales Office immediately. The front of this manual contains the warranty information.

Standard purchase items

Verify that you have received the following items with your unit. If anything is missing or damaged, please contact the nearest Agilent Sales Office.

- ✓ Standard test leads with 4 mm probes
- ✓ Soft carrying case
- ✓ Agilent U1211A, U1212A, and U1213A Clamp Meter Quick Start Guide
- ✓ Certificate of Calibration

Keep the original packaging in case the clamp meter has to be returned to Agilent in the future. If you return the clamp meter for service, attach a tag identifying the owner and model number. Also, include a brief description of the problem occurred.

Product at a glance

The front panel at a glance

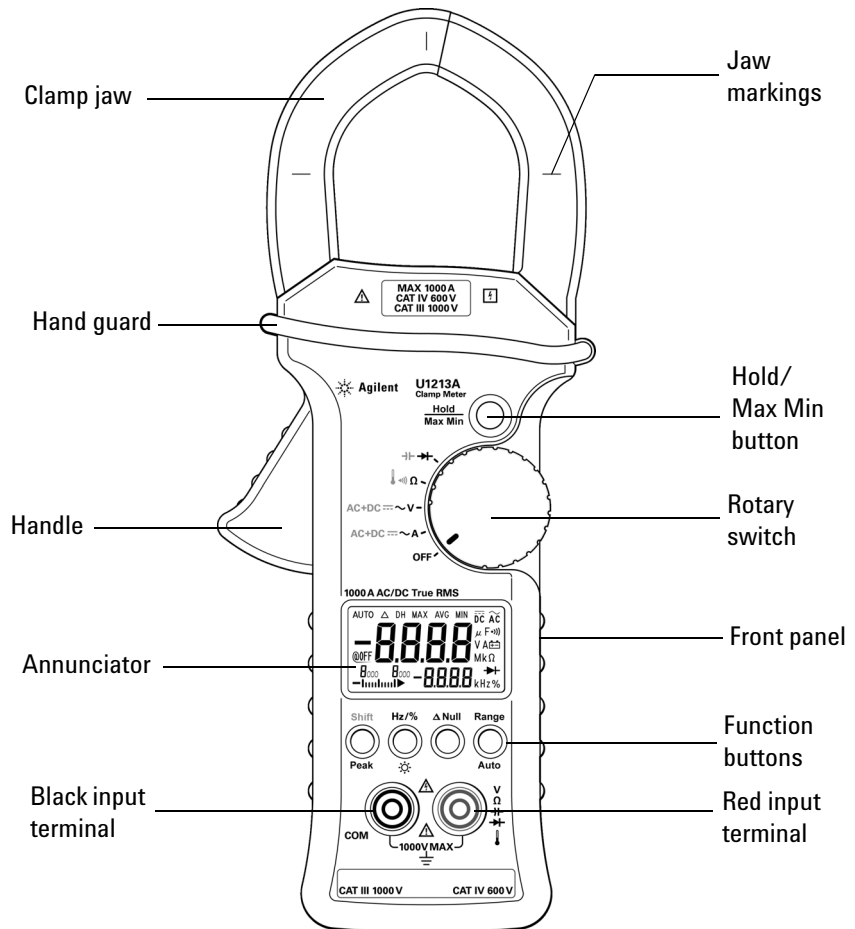

Figure 1-2 Clamp meter front panel

The annunciator display at a glance

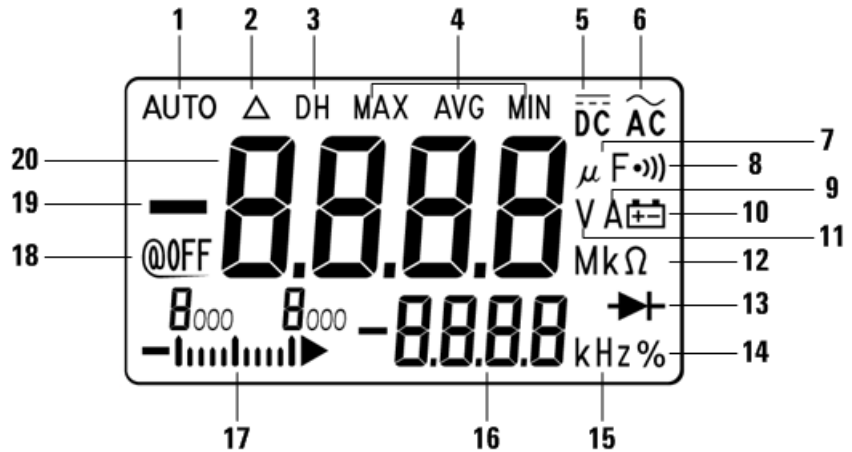





Figure 1-3 LCD annunciator display with full segments displayed

The U1211A, U1212A, and U1213A clamp meters annunciator display indicates the measurement values, functions, and status of the clamp meter. To view the full display (with all segments illuminated), press and hold **Hold/Max Min** while rotating the rotary switch to **~A** on the clamp meter. After you are done viewing the full display, press and hold **Hold/Max Min**, again to resume normal operation.

Table 1-1 U1211A, U1212A, and U1213A annunciator display

No.	Annunciator	Description
1	AUTO	Auto ranging
2	Δ	Zeroing mode
3	DH	Data hold
4	MAX AVG MIN	Dynamic recording mode on present reading. MAX: maximum reading, MIN: minimum reading, AVG: average reading
5	DC	Direct current or voltage
6	AC	Alternating current or voltage

Table 1-1 U1211A, U1212A, and U1213A annunciator display (continued)

No.	Annunciator	Description
7	μ F	Capacitor measurement unit
8	•))	Audible continuity indicator
9	A	Current measurement unit
10		Low battery indicator when battery voltage drops below 6.0 V
11	V	Voltage measurement unit
12	M k Ω	Resistance measurement unit and range
13		Diode measurement indicator
14	%	Duty cycle (for U1213A only)
15	kHz	Frequency measurement unit
16	-8.8.8.8	Secondary display (for frequency and duty cycle measurement, and temperature unit)
17		Analog bar-graph with scale indicator
18	@OFF	Auto power-off enabled
19		Negative polarity
20	8.8.8.8	Primary display

Analog bar-graph

The analog bar-graph emulates the needle on an analog meter without displaying the overshoot. When measuring peak or null adjustments and viewing fast-changing inputs, the bar graph provides a useful indication because it has a faster updating rate to cater for fast-response applications. The bar-graph is not applicable for temperature measurement. A negative sign will be indicated whenever a negative value is measured. Each segment of the analog bar-graph is represented by a count of 100.

Table 1-2 Analog bar-graph ranges

Measurement range	Bar-graph display
0 to 1000	
1000 to 2000	
2000 to 3000	
3000 to 4000	

The buttons at a glance

The operation of each button is shown below. Pressing a key changes the current operation, changes the status in the annunciator on the display, and generates a button-click sound (a beep).

Using the Hold/Max Min button

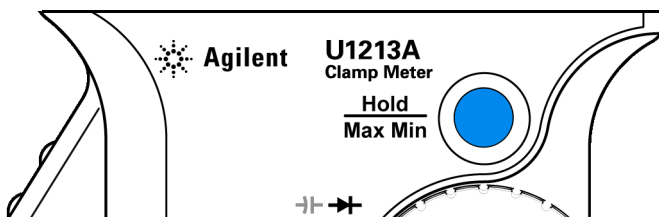



Figure 1-4 Hold/Max Min button

The **Hold/Max Min** button on the clamp meter has two functions: *data hold* and *dynamic recording*. See “[Data Hold \(Trigger Hold\)](#)” on page 52 and “[Dynamic Recording](#)” on page 56 for more information.

Table 1-3 Hold/Max Min button description

Button	Description
	<ul style="list-style-type: none"> Press Hold/Max Min momentarily to perform data hold operation. The annunciator display will indicate DH, which means a reading has been frozen. Press and hold Hold/Max Min for more than 1 second to disable data hold operation. Press Hold/Max Min for more than 1 second (with the data hold function turned off) to perform dynamic recording mode. The annunciator display will first indicate MAX AVG MIN. Press Hold/Max Min momentarily to cycle through dynamic recording (maximum, minimum, or average) functions. Press and hold Hold/Max Min for more than 1 second to disable dynamic recording function.

In Setup mode, the **Hold/Max Min** button is designated as a *Save* button. See “[Selecting Setup Menu](#)” on page 64 for more information.

Using the clamp meter buttons

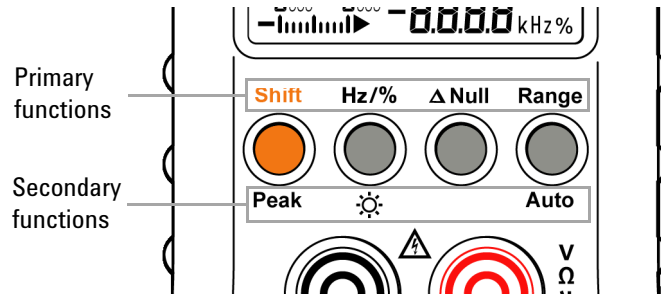









Figure 1-5 Function and status buttons

The buttons located between the annunciator display and input terminals have two functions: the primary functions (labels printed above the buttons) and secondary functions (labels printed below the buttons). The primary function is accessible by pressing the button momentarily, while the secondary function is accessible by pressing the button for more than 1 second. Only **Δ Null** do not have secondary function.

Button	Description
<p>Shift</p>  <p>Peak</p>	<ul style="list-style-type: none"> Press Shift/Peak momentarily to perform a <i>shifted</i> function. The <i>shifted</i> function is mostly used with the rotary switch to cycle between measurement functions. See “The rotary switch at a glance” on page 30 for more information. Press Shift/Peak for more than 1 second to perform Peak function. See “1 ms Peak Hold” on page 59 for more information.
<p>Hz/%</p>  <p></p>	<ul style="list-style-type: none"> Press Hz/%/  momentarily to enable frequency measurement on the secondary display in the annunciator display. Press Hz/%/  momentarily again (after enabling frequency measurement) to perform duty cycle (%)^[1] function. Press Hz/%/  for more than 1 second to enable backlight illumination.

Button	Description
<p>Δ Null</p> 	<p>Press Δ Null momentarily to enable the null math operation. See “Null (Relative)” on page 61 for more information.</p>
<p>Range Auto</p> 	<ul style="list-style-type: none"> • Press Range/Auto momentarily to scroll through the available measurement ranges (except diode and capacitance measurement). • Press Range/Auto for more than 1 second to enable automatic range detection (except diode and capacitance measurement). Press Range/Auto momentarily to disable automatic range detection.

[1] The duty cycle function is only available for U1213A clamp meter.

The rotary switch at a glance

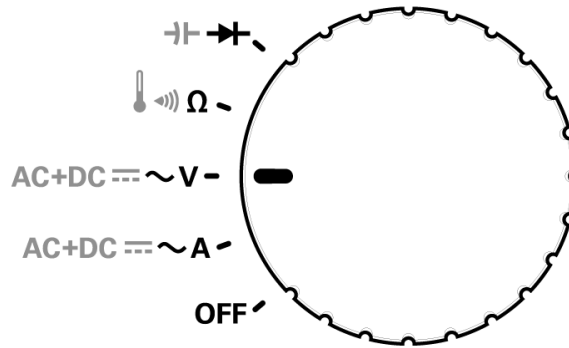



Figure 1-6 Clamp meter rotary switch

The rotary switch allows you select desired measurements. To cycle between measurements after rotating to a particular measurement function, press **SHIFT**.

Measurement function	Description
OFF	Power off.
AC+DC \sim A	AC, DC ^[1] , or AC + DC ^[2] current measurements. By default, measurement is set to AC current.
AC+DC \sim V	AC, DC, or AC + DC ^[2] voltage measurements. By default, measurement is set to AC voltage.
	Resistance measurement, audible continuity test, or temperature ^[1] measurement. By default, the measurement is set to resistance measurement.
	Diode or capacitance measurement. By default, measurement is set to diode measurement.

[1] The temperature measurement and DC current measurement are only available for U1212A and U1213A clamp meters.

[2] The AC + DC measurement is only available for U1213A clamp meter.

The terminals at a glance

WARNING

Ensure that the terminal connections are correct for a particular measurement before making any measurement. To avoid damage to the device, do not exceed the input limit.

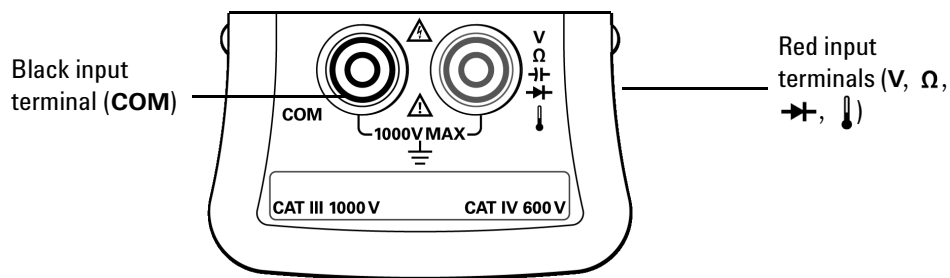





Figure 1-7 Clamp meter terminal inputs

Table 1-4 Terminal connections for different measurement functions

Measurement functions	Input terminals		Input limit
AC current	Clamp jaw		1000 A _{rms}
DC current ^[1]			
AC voltage	V	COM	CAT III 1000 V _{rms}
DC voltage			CAT IV 600 V _{rms}
Resistance	Ω    	COM	1000 V _{rms} for short circuit < 0.3 A
Capacitance			
Diode			
Temperature ^[2]			

[1] DC current measurement is only available for U1212A and U1213A clamp meters.

[2] Temperature function is only available for U1212A and U1213A clamp meters.

The clamp jaw at a glance

The clamp jaw is used to perform current measurement without having to make physical contact with or disconnecting the conductor. The clamp jaw can be opened and closed, allowing a maximum opening of 2 inches. Press the handle of the clamp meter to open the clamp jaw. When measuring current, there are 3 jaw markings to observe. Current is measured accurately by placing the conductor in the middle of the 3 jaw markings. See “Performing Current Measurement” on page 36 for more information on performing current measurements.

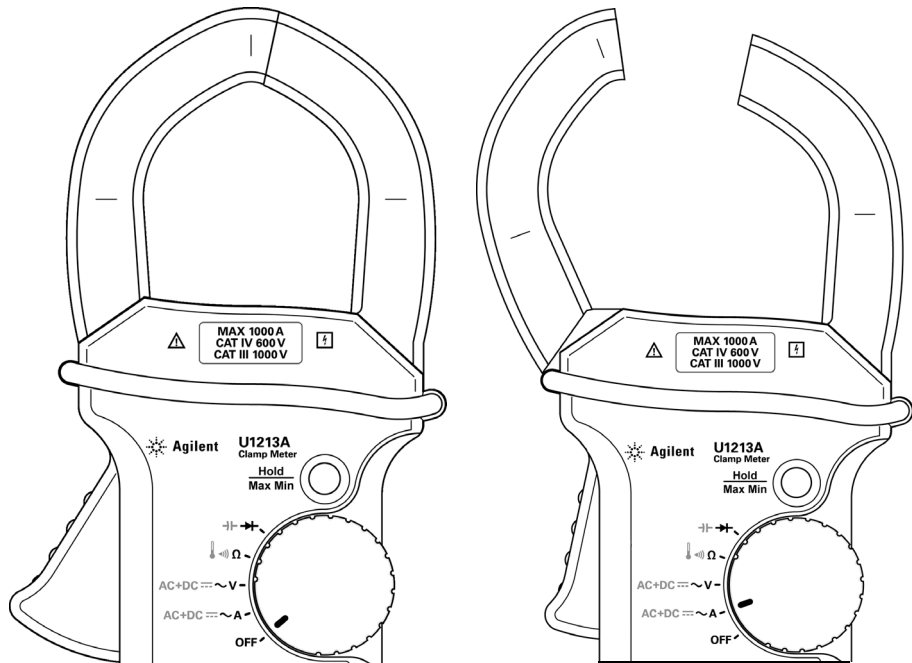

Figure 1-8 Clamp jaw close and open state

The rear panel at a glance

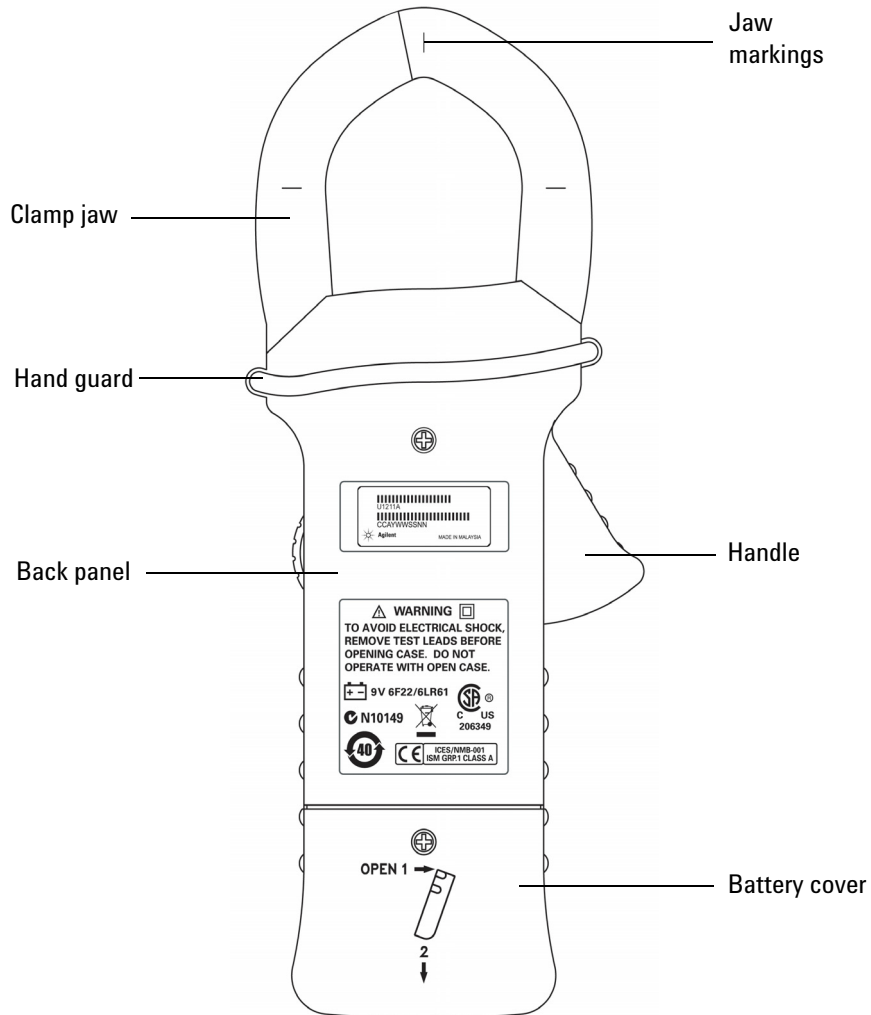

Figure 1-9 Clamp meter rear panel

1 Getting Started
Product at a glance



2 Making Measurements

Performing Current Measurement	36
Performing Voltage Measurement	38
Performing Resistance Measurement and Continuity Test	40
Performing Diode Measurement	43
Performing Capacitance Measurement	46
Performing Temperature Measurement	48

This chapter contains many types of measurements that you can make with the U1211A, U1212A, and U1213A Clamp Meters, and how to make the connections for each measurement.

WARNING

Ensure that the terminal connections are correct for a particular measurement before making any measurement. To avoid damage to the device, do not exceed the input limit.



Performing Current Measurement

WARNING

Ensure the test leads are disconnected from the input terminals when measuring current with the clamp meter.

CAUTION

Ensure that the clamp meter measures only one conductor at a time. Measuring multiple conductors may cause inaccuracy in measurement reading due to vector sum of currents flowing in the conductors.

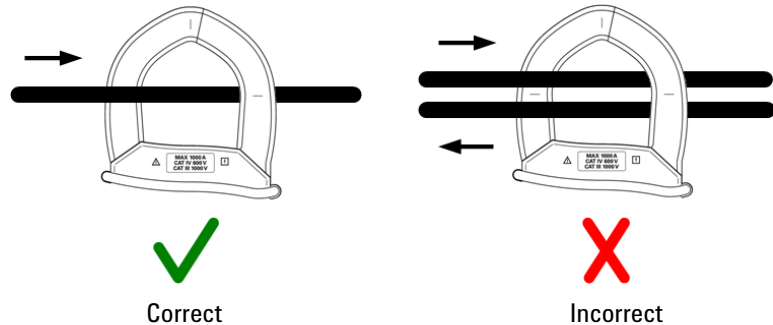

Steps (see [Figure 2-1](#) on page 37):

- 1 Set the rotary switch to **~A**.
- 2 Press **Shift** once to switch between AC current, DC current (for U1212A and U1213A only), and AC + DC current (for U1213A only) measurements.
- 3 Press the handle to open the clamp jaw.
- 4 Clamp around a conductor and ensure that the conductor fits the markings on the jaw.
- 5 Read the display. Press **H_z** to view the frequency indication on the secondary display.

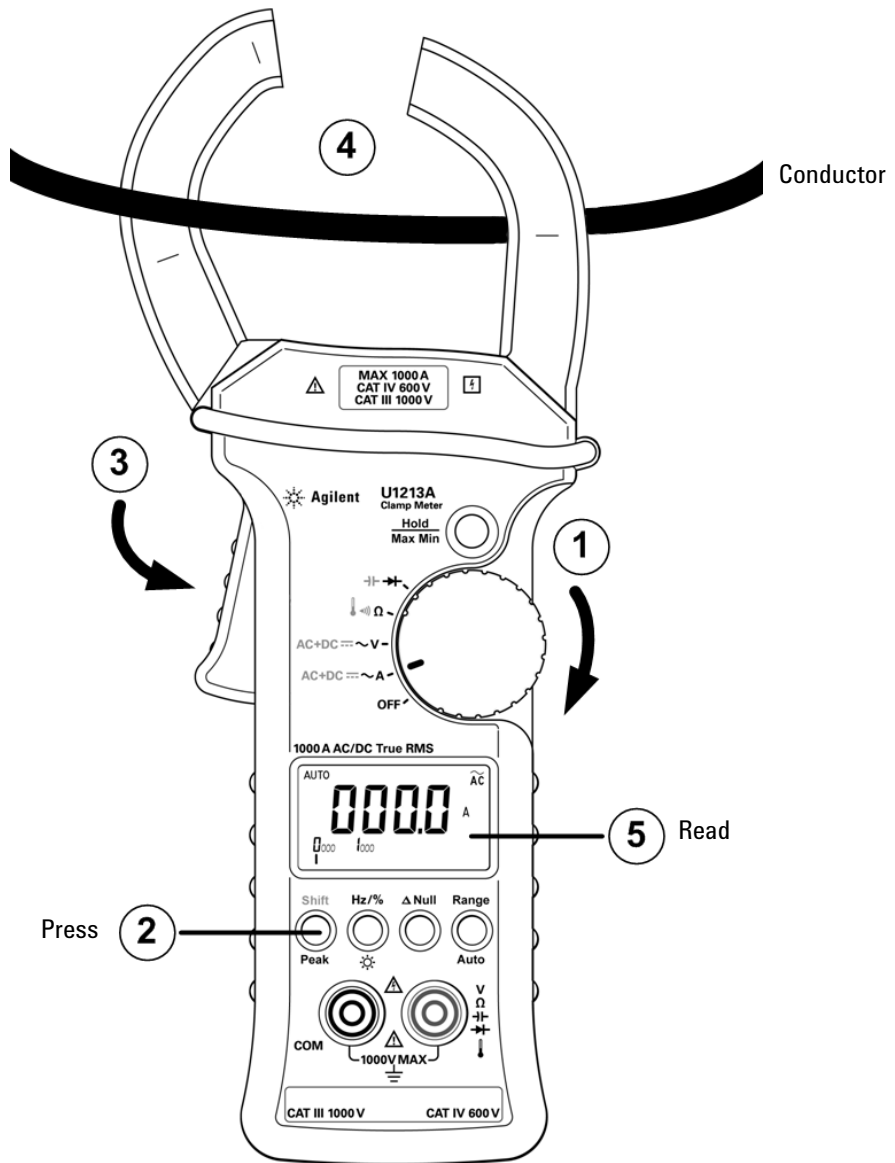

Figure 2-1 Measuring current

2 Making Measurements

Performing Voltage Measurement

Performing Voltage Measurement

Steps (Figure 2-2 on page 39):

- 1 Set the rotary switch to **~V**.
- 2 Connect the red and black test leads to input terminals V (**red**) and COM (black) respectively.
- 3 Press **Shift** to switch between AC voltage, DC voltage, and AC + DC voltage (for U1213A only) measurements.
- 4 Probe the test points and read the display. Press **Hz** to view the frequency indication on the secondary display.

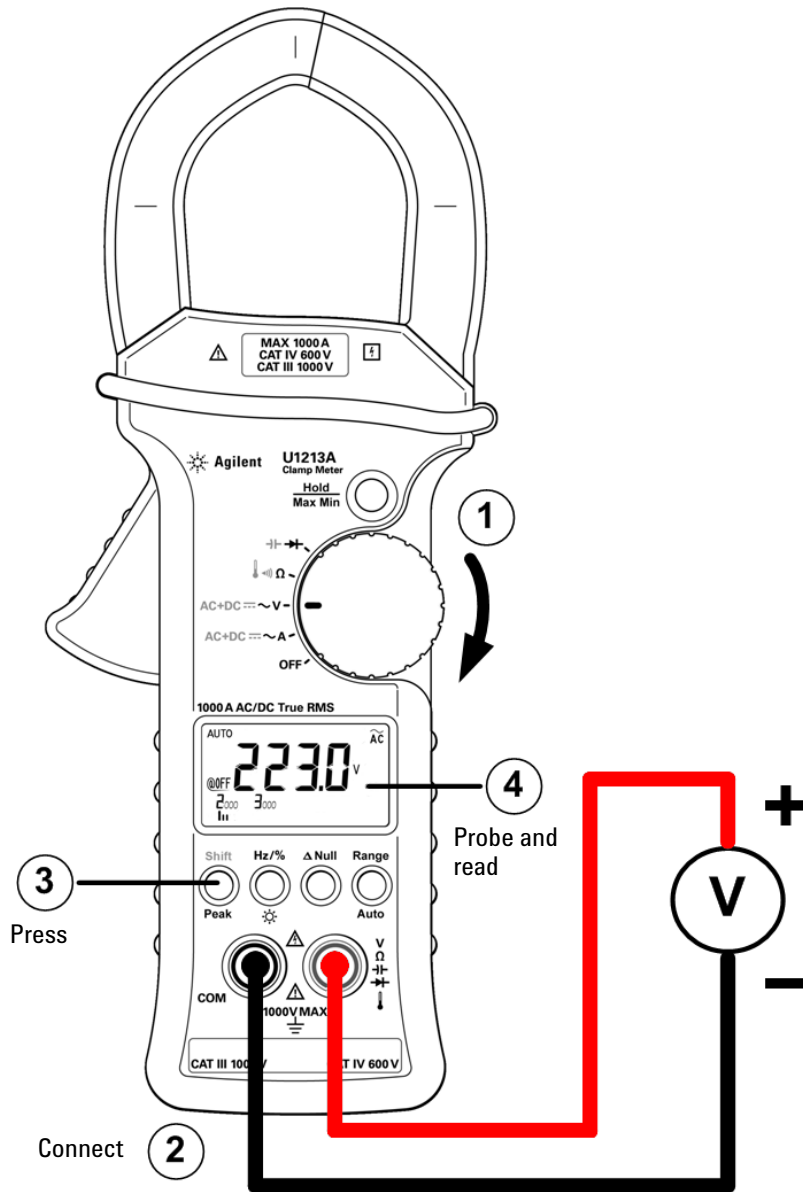

Figure 2-2 Measuring voltage

2 Making Measurements

Performing Resistance Measurement and Continuity Test

Performing Resistance Measurement and Continuity Test

CAUTION

Disconnect circuit power and discharge all high-voltage capacitors before measuring resistance or conductance, or testing circuit continuity, to avoid damaging the clamp meter or the device under test.

Steps ([Figure 2-3](#) on page 41):

- 1 Set the rotary switch to Ω .
- 2 Connect the red and black test leads to input terminals Ω (red) and COM (black) respectively.
- 3 Probe the test points (by shunting the resistor) and read the display.
- 4 To perform continuity test, press **Shift** once (see [Figure 2-4](#) on page 42). The buzzer will sound when the resistance is below 10.0 Ω .

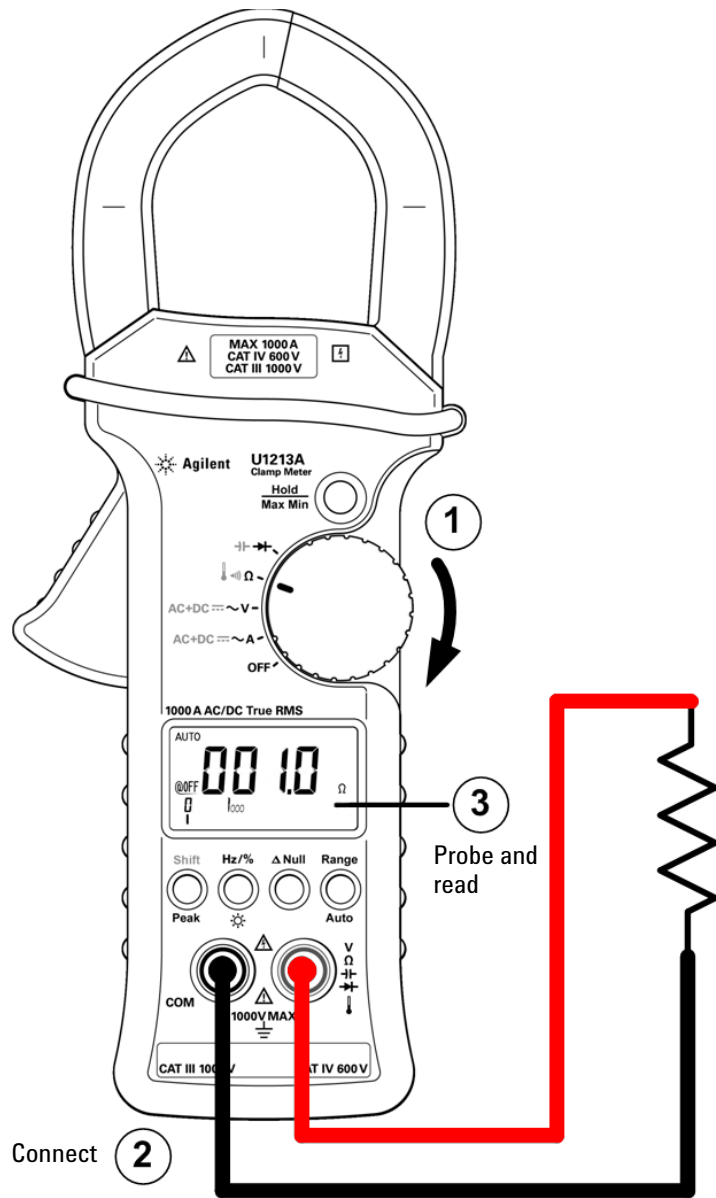

Figure 2-3 Measuring resistance

2 Making Measurements

Performing Resistance Measurement and Continuity Test

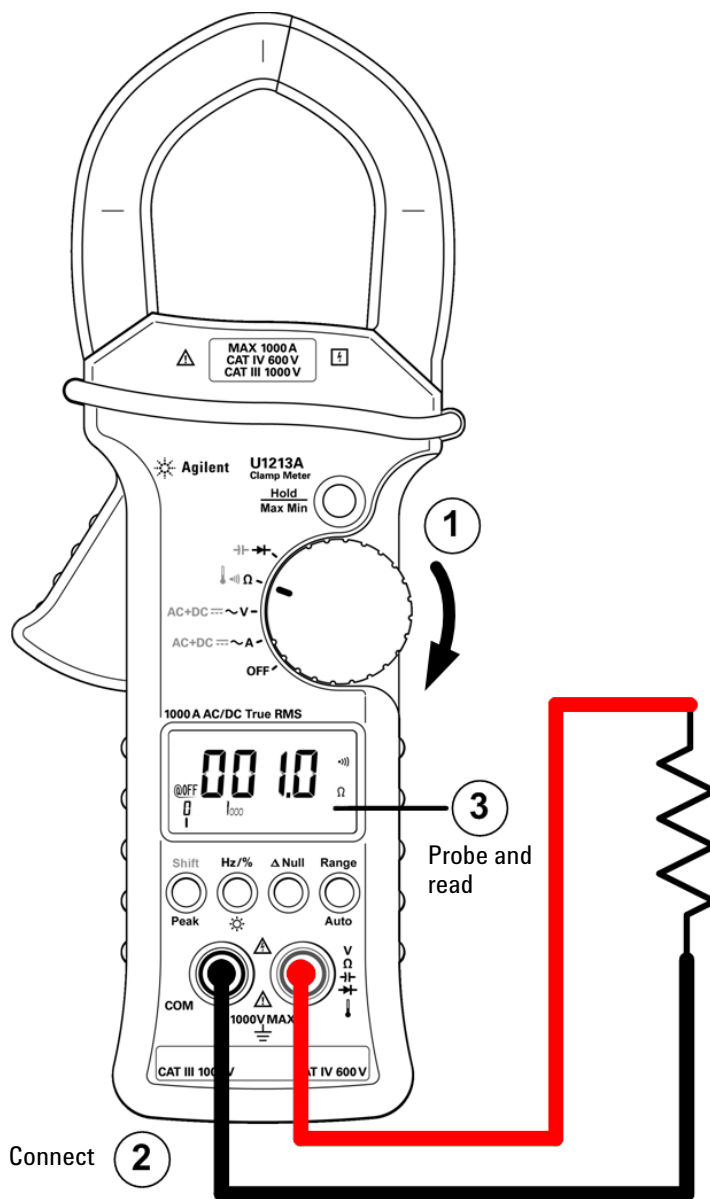



Figure 2-4 Continuity test

Performing Diode Measurement

CAUTION

Disconnect circuit power and discharge all high-voltage capacitors before testing diodes to avoid damaging the clamp meter.

Steps (see [Figure 2-5](#) on page 44):

- 1 Set the rotary switch to . The auto range mode will be disabled (if the auto range mode was enabled).
- 2 Connect the red and black test leads to input terminals  (red) and COM (black) respectively.
- 3 Probe the test points and read the display.

NOTE

This clamp meter can display diode forward bias of up to approximately 2.1 V. The forward bias of a typical diode is within the range of 0.3 V to 0.8 V.

- 4 Reverse the probes and measure the voltage across the diode again (see [Figure 2-6](#) on page 45). Assess the diode according to the following guidelines:
 - A diode is considered good if the clamp meter displays “OL” in reverse bias mode.
 - A diode is considered shorted if the clamp meter displays approximately 0 V in both forward and reverse bias modes, and the clamp meter beeps continuously.
 - A diode is considered open if the clamp meter displays “OL” in both forward and reverse bias modes.

2 Making Measurements

Performing Diode Measurement

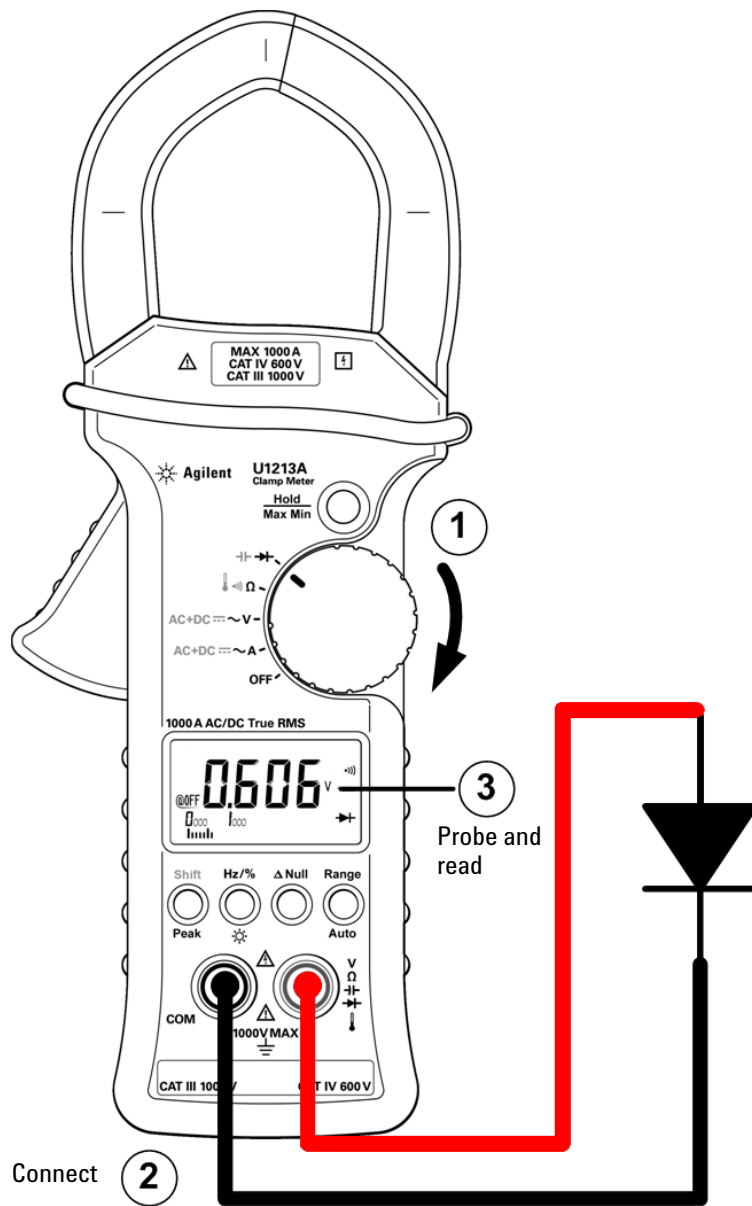

Figure 2-5 Measuring diode (forward bias)

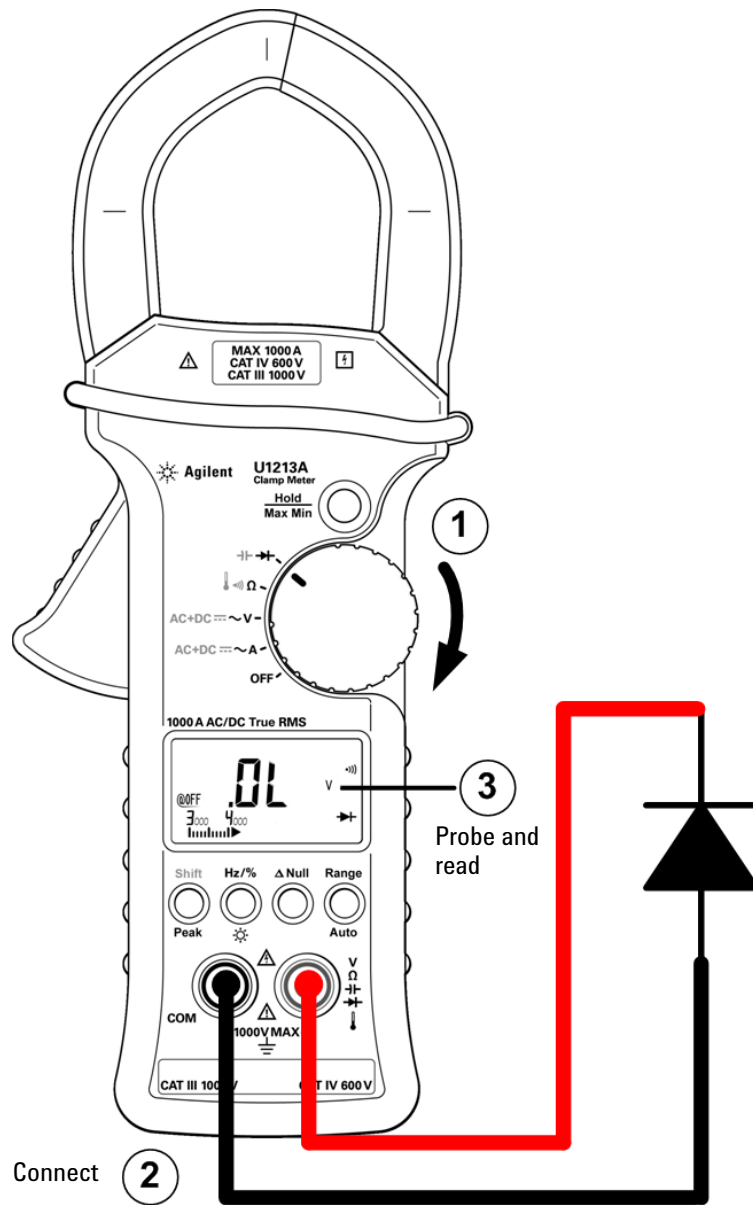

Figure 2-6 Measuring diode (reverse bias)

Performing Capacitance Measurement

CAUTION

Disconnect circuit power and discharge all high-voltage capacitors before measuring capacitance to avoid damaging the clamp meter or the device under test. To confirm that a capacitor has fully discharged, use the DC voltage function.

The U1211A, U1212A, and U1213A Clamp Meter measures capacitance by charging a capacitor with a known current for a period of time, and then measuring the voltage.

NOTE

Measuring tips:

- For measuring capacitance greater than 4000 μF , discharge the capacitor and manually select a suitable measurement range. This will speed up measuring time in order to obtain the correct capacitance value.
- Ensure correct polarity when measuring polarized capacitors.
- For measuring small capacitance values, press **Δ Null** with the test leads open to subtract the residual capacitance of the clamp meter and leads.

Steps (see [Figure 2-7](#) on page 47):

- 1 Set the rotary switch to **$\rightarrow\leftarrow$** .
- 2 Press **Shift** to select capacitance measurement.
- 3 Connect the red and black test leads to input terminals **$\rightarrow\leftarrow$** (red) and COM (black) respectively.
- 4 Probe the test points and read the display.

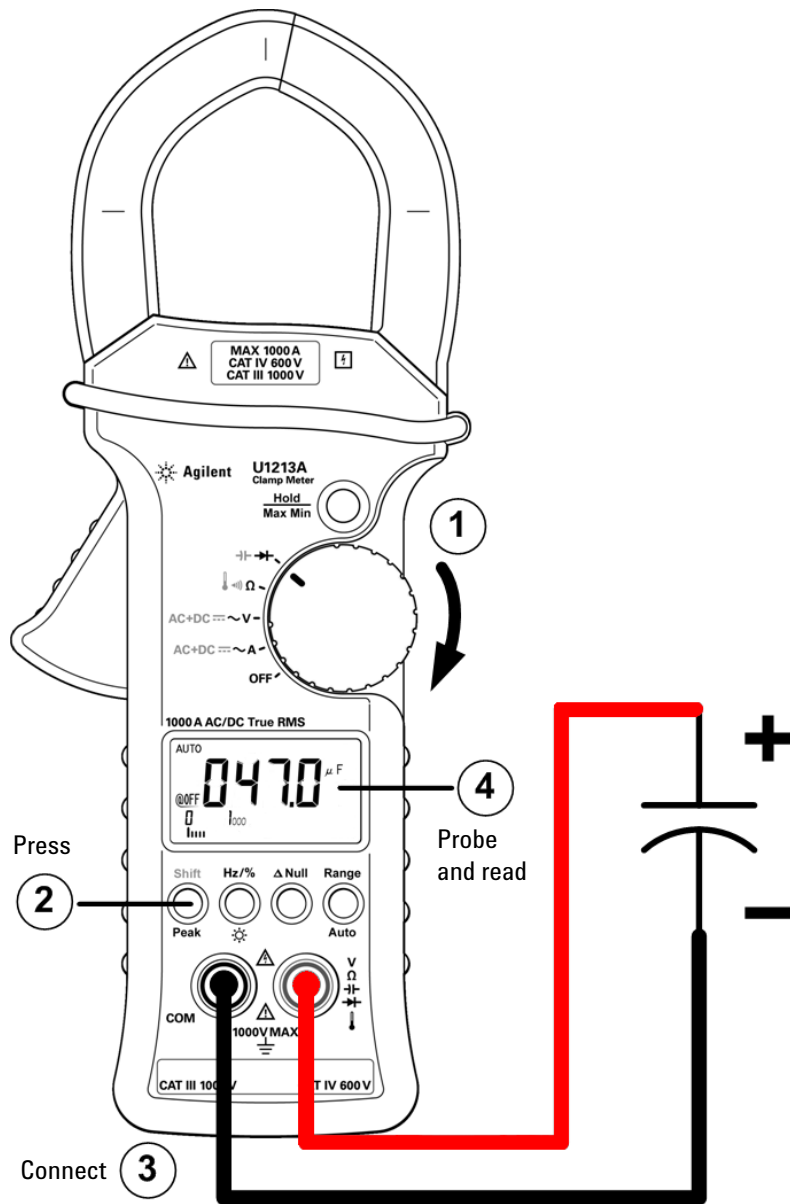

Figure 2-7 Measuring capacitance

Performing Temperature Measurement

Temperature measurement function is only available for U1212A and U1213A only.

NOTE

The bead-type thermocouple probe is suitable for measuring temperatures from $-20\text{ }^{\circ}\text{C}$ to $204\text{ }^{\circ}\text{C}$ in PTFE-compatible environments. Above this temperature range, the probe may emit toxic gas. Do not immerse this thermocouple probe in any liquid. For best results, use a thermocouple probe designed for specific application — an immersion probe for liquid or gel, and an air probe for air measurement. Observe the following measurement settings:

- Clean the surface to be measured and ensure that the probe is securely touching the surface. Remember to disable the applied power.
- When measuring above ambient temperatures, move the thermocouple along the surface until you get the highest temperature reading.
- When measuring below ambient temperatures, move the thermocouple along the surface until you get the lowest temperature reading.
- Place the clamp meter in the operating environment for at least 1 hour as the clamp meter is using non-compensation transfer adapter with miniature thermal probe.

CAUTION

Do not bend the thermocouple leads at sharp angles. Repeated bending over a period of time can break the leads.

Steps (see [Figure 2-8](#) on page 49):

- 1 Set the rotary switch to Ω .
- 2 Press **Shift** twice to select temperature measurement.
- 3 Connect the thermocouple adapter (with the thermocouple probe connected to it) into input terminals **!** (red) and COM (black).
- 4 Touch the measurement surface (device under test) with the thermocouple probe and read the display.

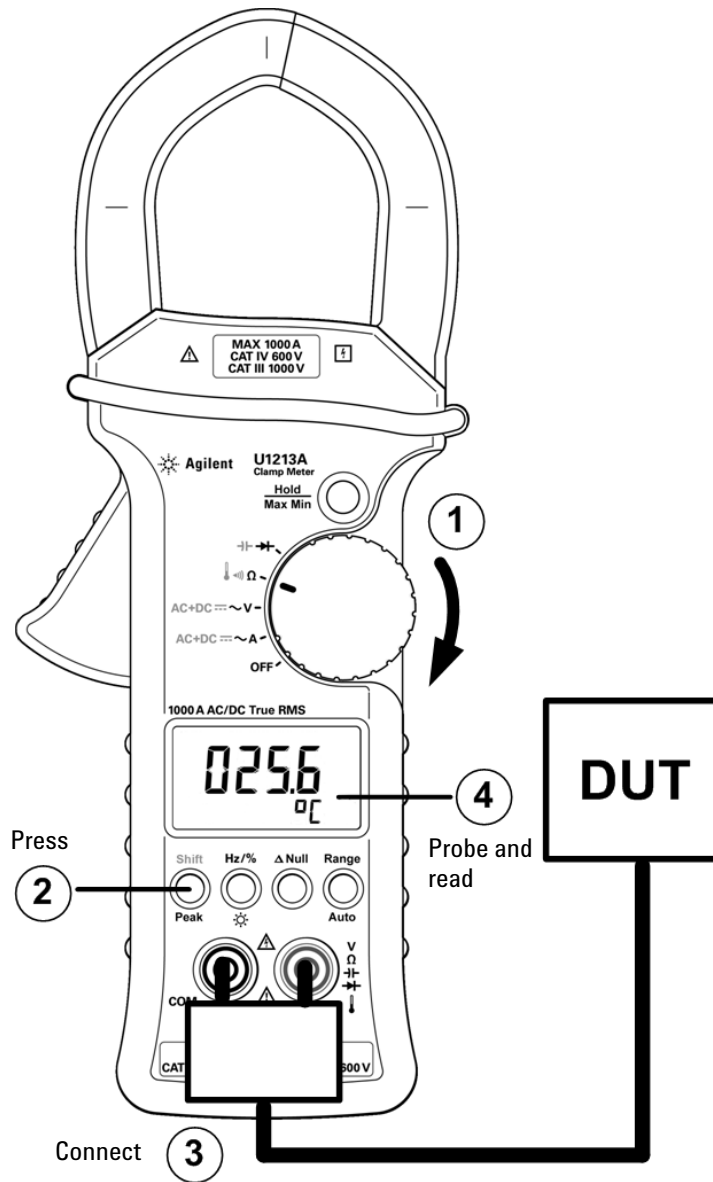

Figure 2-8 Measuring temperature

2 Making Measurements

Performing Temperature Measurement



3 Functions and Features

Data Hold (Trigger Hold)	52
Enabling the data hold function	52
Refresh Hold	54
Enabling the refresh hold function	54
Dynamic Recording	56
Enabling the dynamic recording mode	56
1 ms Peak Hold	59
Enabling the 1 ms peak hold function	59
Null (Relative)	61
Enabling the null operation	61

This chapter contains detailed information on functions and features available in the U1211A, U1212A, and U1213A Clamp Meters.



Data Hold (Trigger Hold)

The data hold operation allows you to capture and hold a reading instantaneously through trigger function. You will have to enable the data hold in setup menu before using the data hold operation. See [“Setting Data Hold/Refresh Hold mode”](#) on page 70 for more information.

Enabling the data hold function

- 1 Ensure that the data hold operation is enabled in the setup menu.
- 2 Press **Hold/Max Min** to enable the data hold operation.
- 3 The annunciator display will indicate **DH** and the data hold function is enabled.
- 4 Press **Hold/Max Min** again to trigger.
- 5 Press **Hold/Max Min** for more than 1 second to exit the data hold operation.

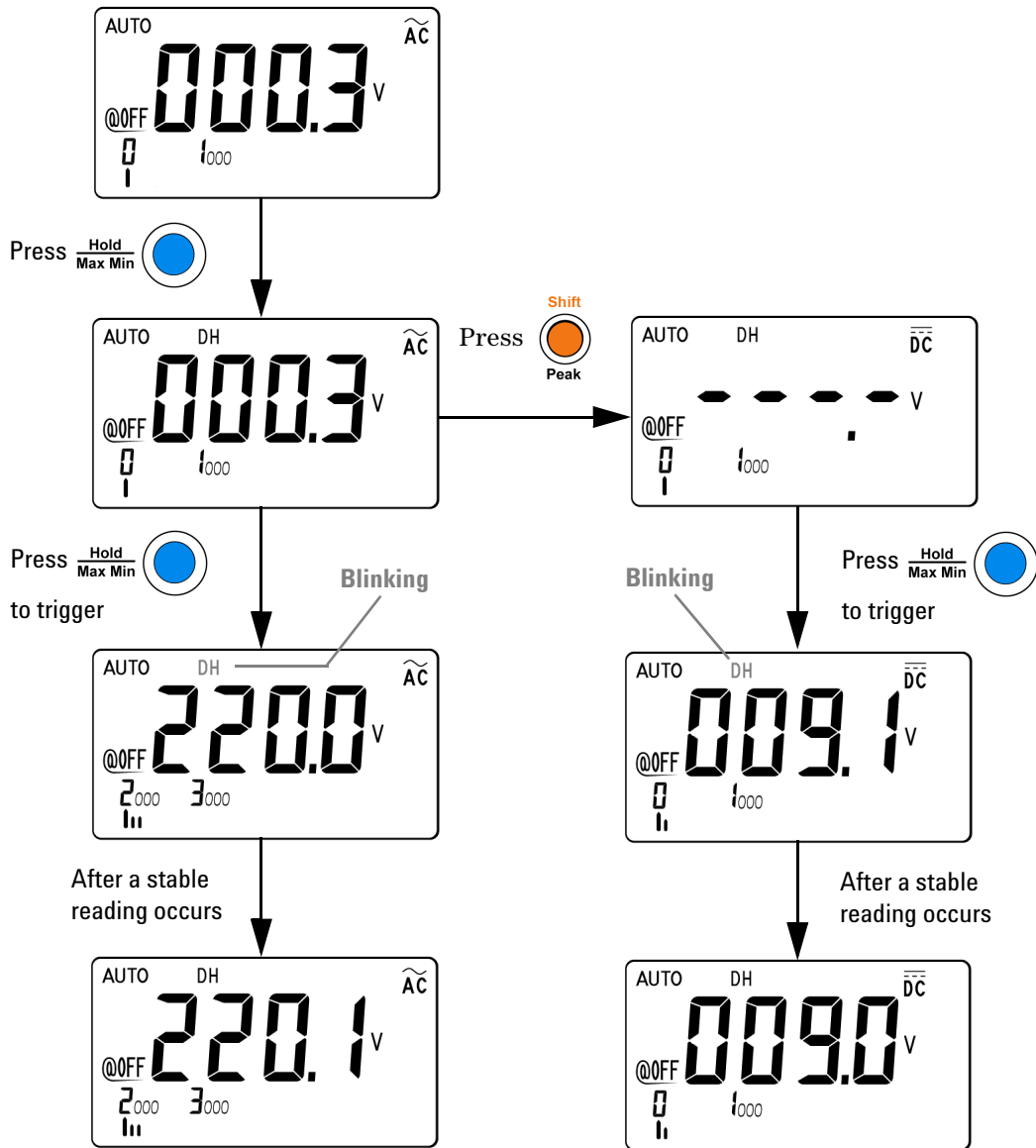

Figure 3-1 Data hold operation

Refresh Hold

The refresh hold operation allows you to capture and hold a reading, within specified variation and threshold values. This is useful in situations when you need to know if the running values of a setup is stable or not.

This is done by comparing the running values to the initial hold value. A preset variation count will determine the range of values that is considered stable in reference to the initial hold value. You can set the variation count through the setup menu. Refer to [Chapter 4](#), “Setting Data Hold/Refresh Hold mode,” starting on page 70 on how to set the variation count.

When a stable reading is first detected, the instrument beeps once (if the beeper is enabled), and holds the reading (the initial hold value) on the primary display. The instrument will then compare the running values to the hold value to check if the variation value exceeds the set variation count.

A new reading value will be updated in the primary display when the variation of the measured value exceeds the variation count preset in the setup menu. The instrument beeps once (if the beeper is enabled) when a reading value is updated.

For voltage, current, and capacitance measurements, the reading value will not be updated when the reading falls below the threshold preset in the setup menu.

For continuity and diode tests, the reading value will not be updated when an open state is detected.

Enabling the refresh hold function

- 1 Ensure that the data hold operation is disabled in the setup menu.
- 2 Press **Hold/Max Min** to enable the refresh hold operation. A **DH** will be shown on the annunciator display.
- 3 The clamp meter will be ready to hold new measuring value whenever the variation of value exceed the setting of variation count. The **DH** on the annunciator display will blink. The value held earlier will be updated until the measuring value is stable.

- 4 Press **Hold/Max Min** for more than 1 second to exit the refresh hold operation.

NOTE

If the reading is unable to reach a stable state (when exceeding the preset variation), the reading value will not be updated.

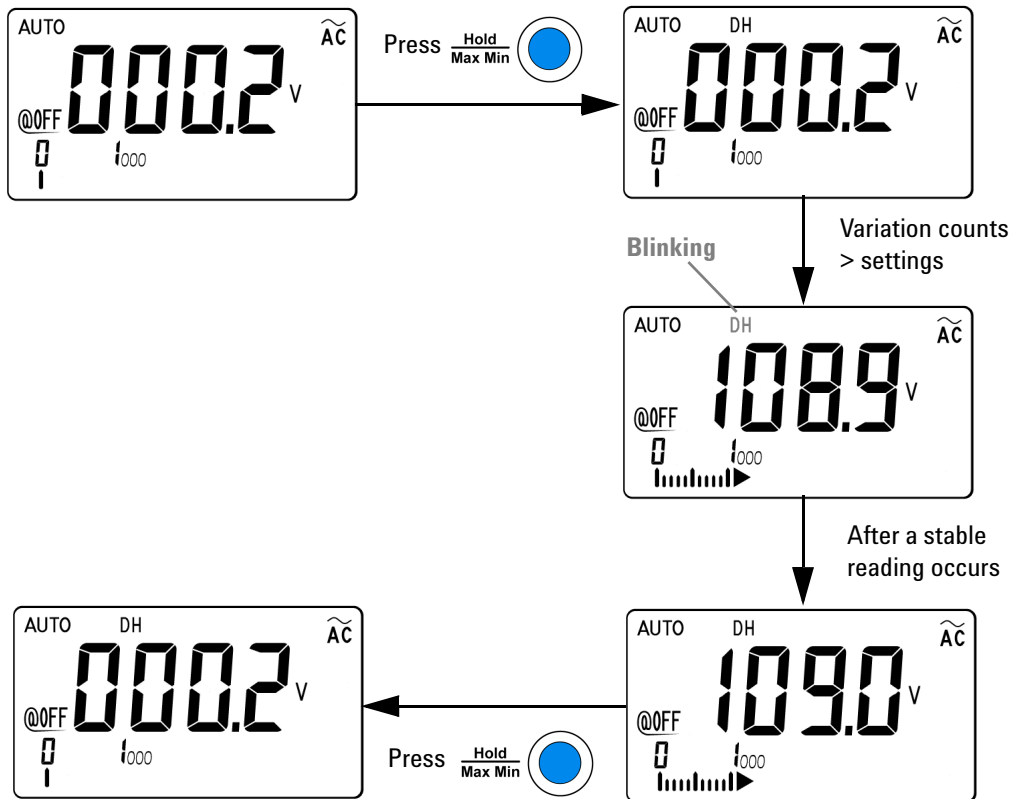

Figure 3-2 Refresh hold operation

Dynamic Recording

The dynamic recording mode can be used to detect intermittent turn-on or turn-off voltage or current surges, and to verify measurement performance without you being present during the process. While the readings are being recorded, you may perform other tasks.

The average reading is useful for smoothing out unstable inputs, estimating the percentage of time a circuit is operating, and verifying circuit performance.

The dynamic recording mode stores the maximum and minimum values, the average, and the number of readings during a series of measurements. From the annunciator display, you can view the following statistical data for any set of readings: maximum (**MAX**), average or mean (**AVG**), and minimum (**MIN**).

Enabling the dynamic recording mode

- 1 Press **Hold/Max Min** for more than 1 second to enable the dynamic recording mode. The annunciator display will indicate **MAX AVG MIN**. You are currently in present reading state.
- 2 Press **Hold/Max Min** momentarily to cycle through the maximum reading (the **MAX** function indicated), minimum reading (the **MIN** function indicated), or average reading (the **AVG** function indicated). Each time a new maximum or minimum value is recorded, the instrument beeps once (if the beeper is enabled).
- 3 Press **Hold/Max Min** for more than 1 second again to disable the dynamic recording mode.

NOTE

- If an overload is recorded, the average reading recording will stop. The average reading value indicates “**OL**” (overload) on the primary display.
- If the dynamic recording mode is enabled with auto range, the value of **MAX**, **MIN**, and **AVG** for different ranges will be recorded.
- During the dynamic recording mode, the auto power-off feature is automatically disabled.

The instrument calculates the average of all readings and records the number of readings taken since the dynamic recording mode was enabled.

Accumulated statistics are:

- Max Avg Min: present reading (actual input signal value)
- Max: maximum reading since the dynamic recording mode was enabled
- Min: minimum reading since the dynamic recording mode was enabled
- Avg: true average of all readings since the dynamic recording mode was enabled

3 Functions and Features

Dynamic Recording

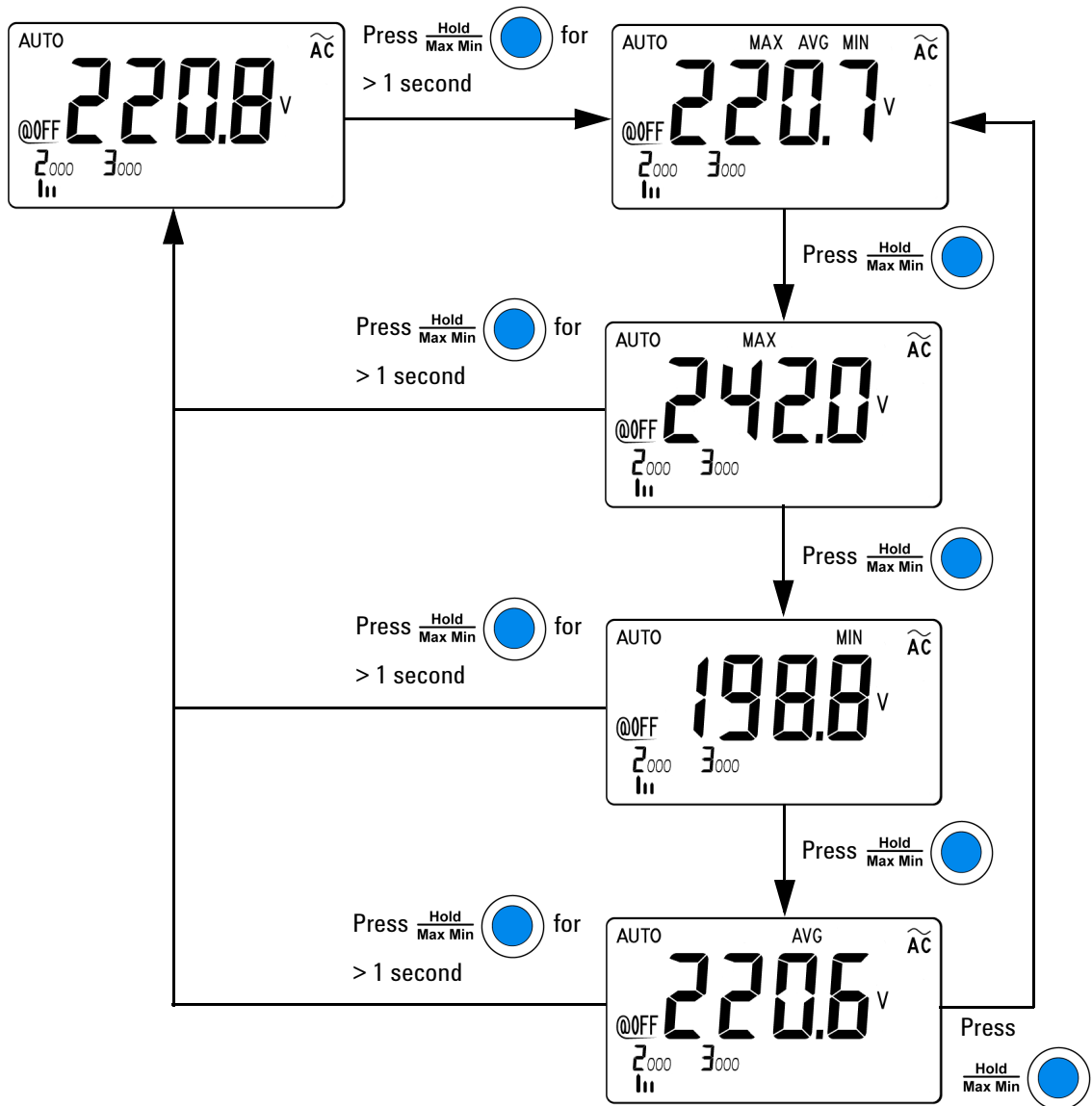

Figure 3-3 Dynamic recording mode

1 ms Peak Hold

This function allows the measurement of peak voltage for analysis of components such as power distribution transformers and power factor correction capacitors. The peak voltage obtained can be used to determine the crest factor:

$$\text{Crest factor} = \frac{\text{Peak value}}{\text{True RMS value}}$$

Enabling the 1 ms peak hold function

- 1 Press **Shift/Peak** for more than 1 second to toggle 1 ms peak hold mode ON and OFF.
- 2 Press **Hold/Max Min** to switch between maximum and minimum peak readings. DH MAX indicates maximum peak, while DH MIN indicates minimum peak (DH MIN minimum peak is only available in U1213A).
- 3 Press **Shift/Peak** for more than 1 second to exit the mode.
- 4 In the measurement example shown in [Figure 3-4](#) on page 60, the crest factor will be $312.2/220.8 = 1.414$.

NOTE

- If the reading is “OL”, press **Range/Auto** to change the measurement range and to restart peak-recording measurement.
- If you need to restart peak recording without changing the range, press **Shift/Peak**.

3 Functions and Features

1 ms Peak Hold

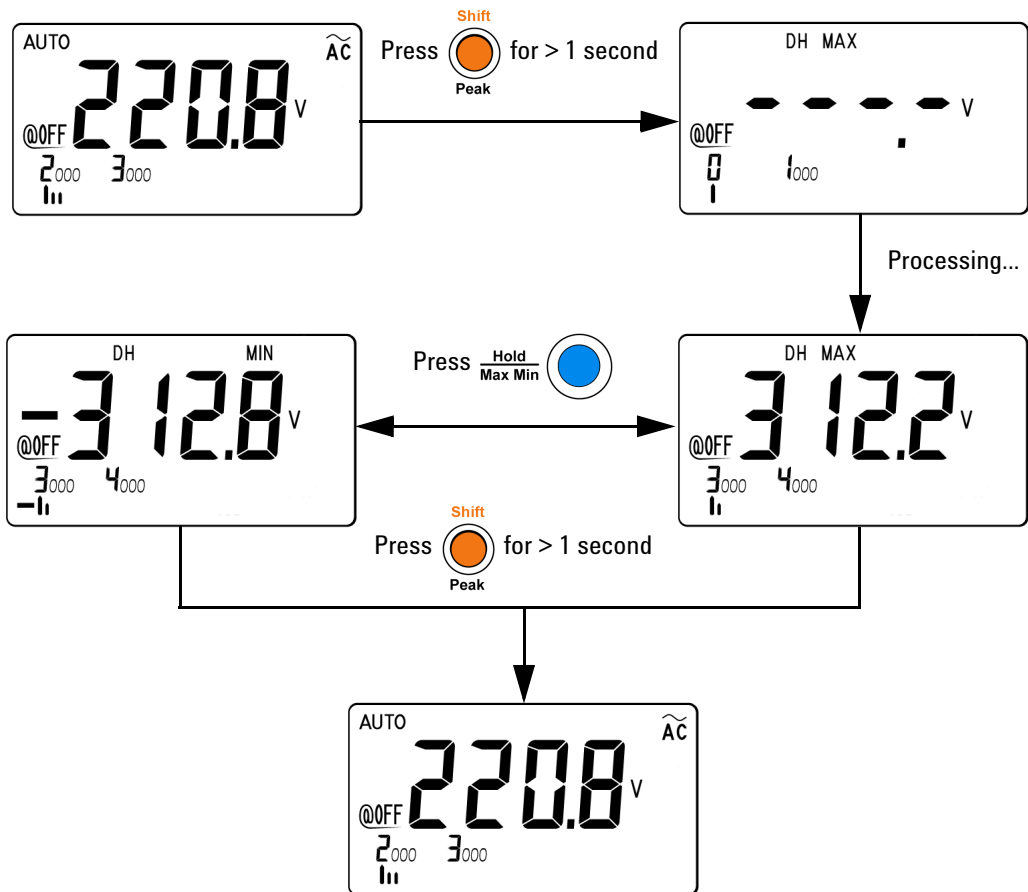

Figure 3-4 1 ms peak hold mode operation

Null (Relative)

When making null measurements, also called relative, each reading is the difference between a stored (selected or measured) null value and the input signal. One possible application is to increase the accuracy of a 2-wire resistance measurement by nulling the test lead resistance. Nulling the lead is also particularly important prior to making capacitance measurements. The formula used for calculating null measurement is:

$$\text{Result} = \text{Reading} - \text{Null value}$$

Enabling the null operation

- 1 Press **Δ Null** to store the displayed reading as the reference value to be subtracted from subsequent measurements and to set the display to zero. The symbol **Δ** is indicated on the annunciator display.
- 2 Press **Δ Null** to view the stored reference value. The symbol **Δ** on the annunciator display blinks for 3 seconds before the display turns to zero.
- 3 To exit this mode, press **Δ Null** while **Δ** is blinking on the annunciator display.

NOTE

- Null can be set for both auto and manual range settings, but not in the event of an overload.
- When taking resistance measurement and the meter reads a non-zero value due to the presence of test leads, use the null function to adjust the display to zero.
- When selecting DC current measurement, the primary display will indicate a non-zero DC current value residual magnetism of the jaw and internal sensor effects. Press **Δ Null** to zero-adjust the display without clamping any conductor.

3 Functions and Features

Null (Relative)

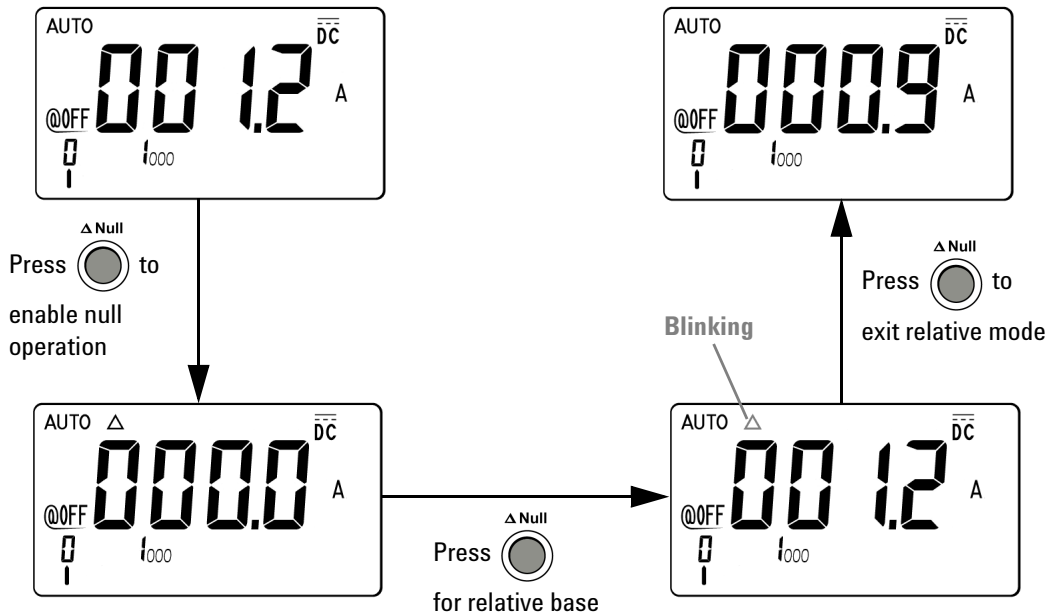
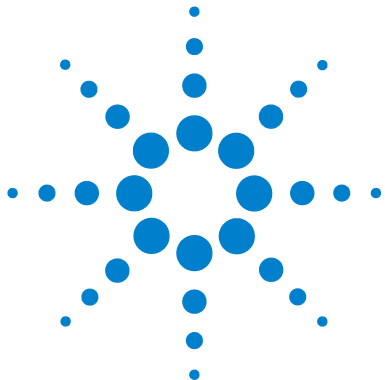

Figure 3-5 Null (relative) mode operation



4 Changing the Default Settings

Selecting Setup Menu	64
Default Factory Settings and Available Setting Options	66
Setting minimum frequency measurement	68
Setting beep frequency	69
Setting Data Hold/Refresh Hold mode	70
Setting auto power-off mode	71
Setting backlight power-on duration	72
Setting temperature unit	72
Returning to default factory settings	75

This chapter describes the various items and settings in the setup menu. This chapter also describes how to change the default factory settings of the U1211A, U1212A, and U1213A Clamp Meters and other available setting options.



Selecting Setup Menu

To access the setup menu, press and hold **Shift/Peak** while rotating the rotary switch to **~A** (or any other measurement functions on the rotary switch) on the clamp meter.

The setup mode menu allows you to customize a number of non-volatile instrument configurations. Modifying these settings affects the operation of your instrument across several functions. Select the setting you want to edit to do the following:

- Switch between two values, such as on or off.
- Select a value from the list.
- Decrease or increase a value by using the directional keys.

The buttons **Hold/Max Min**, **Shift/Peak**, **Hz/%/☼**, **Δ Null**, and **Range/Auto** doubles as save button and directional keypads to toggle the values and to navigate the lists in setup menu.

Table 4-1 Setup mode buttons operation





Setup mode buttons	Description
	Save settings
	Navigation: Left arrow ◀
	Toggle: Down arrow ▼

Table 4-1 Setup mode buttons operation (continued)

Setup mode buttons	Description
<p>△ Null</p> 	<p>Toggle: Up arrow ▲</p>
<p>Range</p>  <p>Auto</p>	<p>Navigation: Right arrow ►</p>

Modifying the settings in setup menu

To change a menu item setting in setup mode, perform the following steps:

- 1 Press ◀ or ▶ to navigate the selected menu pages.
- 2 Press ▲ or ▼ to toggle the item that needs to be changed. A blinking menu indicates that changes have been made in the current settings, but not saved.
- 3 Press **Hold/Max Min** to save the changes you have made.
- 4 Press **Shift/Peak** for more than 1 second to exit the setup mode.

4 Changing the Default Settings

Default Factory Settings and Available Setting Options

Default Factory Settings and Available Setting Options

The following table shows the various menu items with their respective default settings and available options.

Table 4-2 Default factory settings and available setting options for each feature

Feature	Default factory setting	Available setting options
FrEQ	0.5 Hz	Minimum frequency measurement settings. <ul style="list-style-type: none">• Available settings: 0.5 Hz, 1 Hz, 2 Hz, or 5 Hz.
bEEP	4800	Beep frequency. <ul style="list-style-type: none">• Available options: 600 Hz, 1200 Hz, 2400 Hz, 4800 Hz, or OFF.
rHod	500	Refresh hold. <ul style="list-style-type: none">• To enable this function, select a value within the range of 100 to 1000.• To disable this function, select OFF. Note: Select OFF to enable data hold (manual trigger)
AOFF	15	Automatic power-off. <ul style="list-style-type: none">• To enable this function, select a value within the range of 1 minute to 99 minutes.• To disable this function, select OFF.
bl, t	30	Sets the timer to automatically turn off the LCD display backlight. <ul style="list-style-type: none">• To enable this function, select a value within the range of 1 minute to 99 minutes.• To disable this function, select OFF.
ACdC	AC	Initial current or voltage measurement. <ul style="list-style-type: none">• To make AC measurement as the initial measurement, select AC.• To make DC measurement as the initial measurement, select dC. Note: <ul style="list-style-type: none">• The default initial measurement of U1211A, U1212A, and U1213A is AC measurement.
dEFA	rESt	Default factory settings. Select REST to reset the clamp meter to its default factory settings.

Table 4-2 Default factory settings and available setting options for each feature (continued)

Feature	Default factory setting	Available setting options
FILT	ON	Filter for DC voltage or DC current measurement. <ul style="list-style-type: none"> • To enable this function, select ON. • To disable this function, select OFF.
TEMP	°C	Temperature unit. To set, press Range/Auto for more than 1 second when you are in setup mode. <ul style="list-style-type: none"> • Available options: <ul style="list-style-type: none"> • °C: Single display, in °C only. • °F: Single display, in °F only. • °C/°F: Dual display, °C in primary display, °F in secondary. • °F/°C: Dual display, °F in primary display, °C in secondary.

Setting minimum frequency measurement

The minimum frequency setup influences the measurement rates for frequency and duty cycle. The typical measurement rate as defined in the general specifications is based on a minimum frequency of 10 Hz.

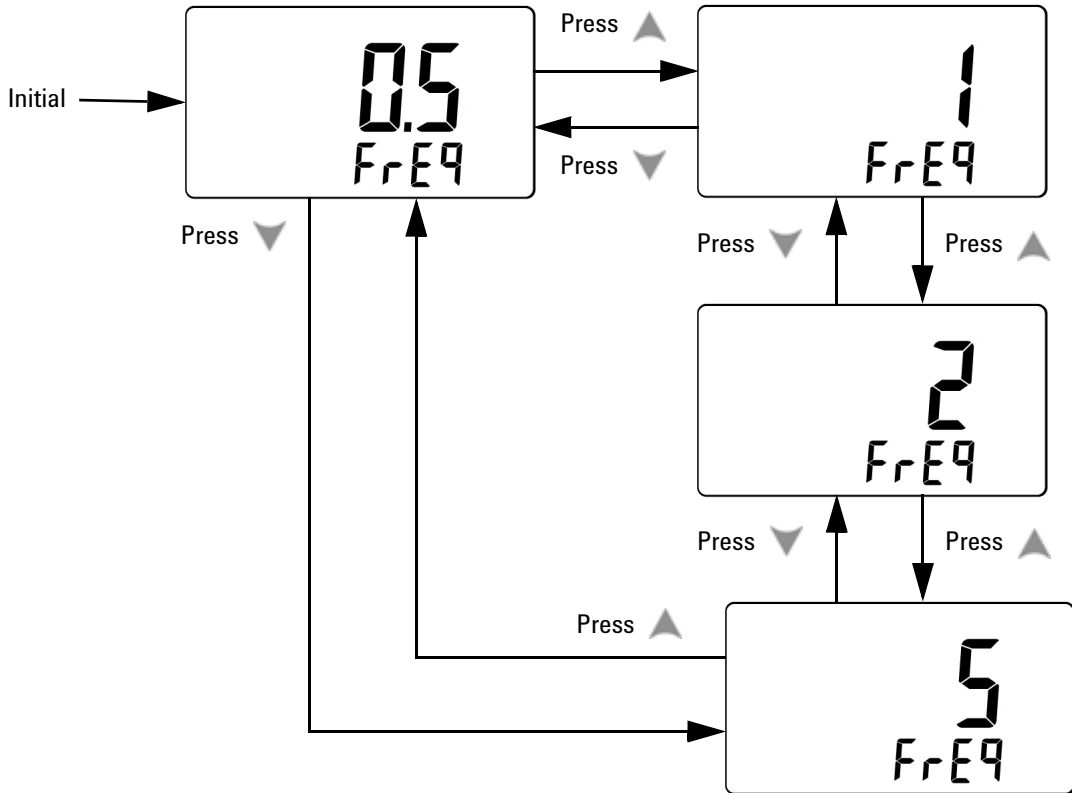

Figure 4-1 Setting the minimum frequency

Setting beep frequency

The beep frequency can be set to 4800 Hz, 2400 Hz, 1200 Hz, or 600 Hz. *OFF* means the beep sound is disabled.

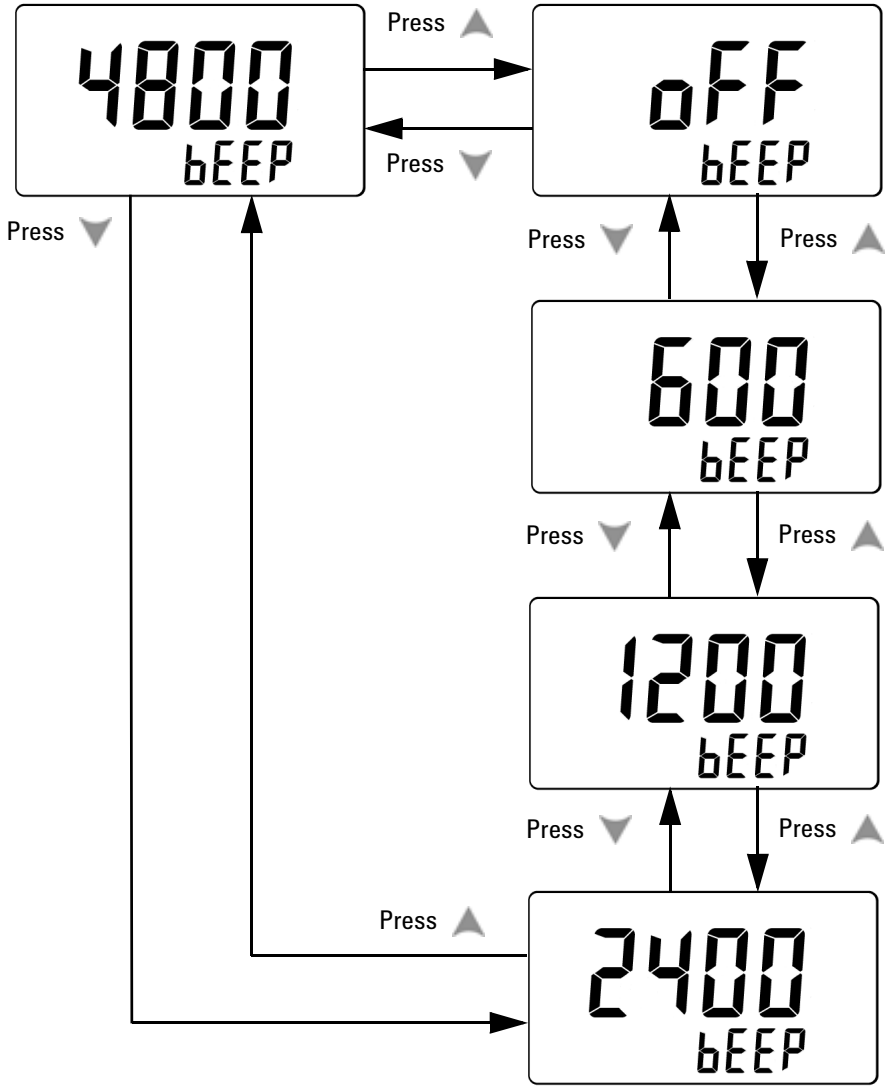

Figure 4-2 Setting the beep frequency

Setting Data Hold/Refresh Hold mode

To enable the data hold mode (manual trigger), set this parameter to OFF.

To enable the refresh hold mode (automatic trigger), set the variation count within the range of 100 to 1000 in a step of 100. Once the variation of the measured value exceeds this preset variation count, the refresh hold mode will be ready to trigger and update a new value.

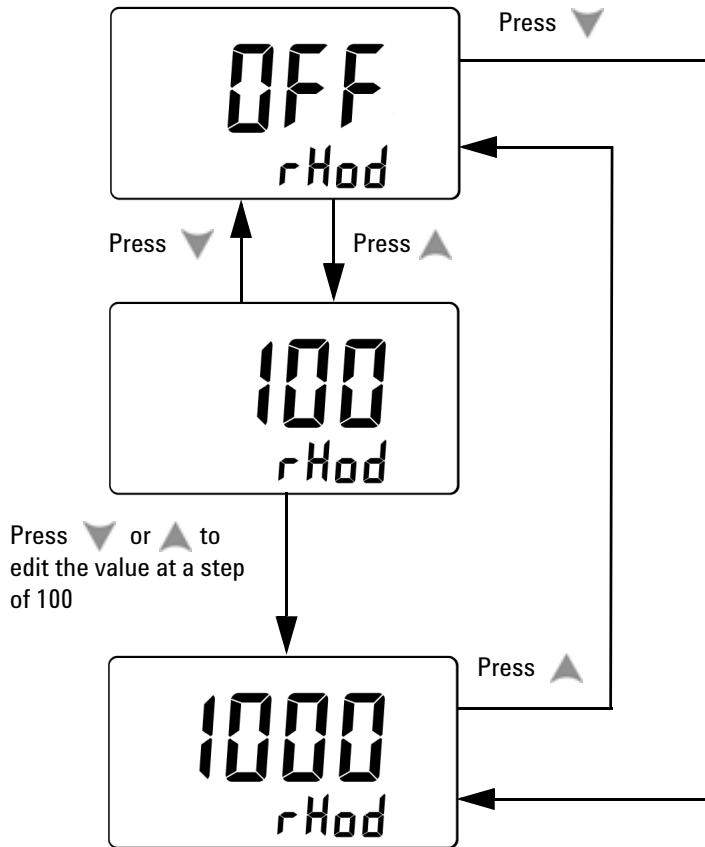

Figure 4-3 Setting the data hold or refresh hold mode

Setting auto power-off mode

To enable auto power-off mode, set its timer to any value within the range of 1 to 99 minutes.

The instrument will turn off automatically (with auto power-off mode enabled) after the specified amount of time, if none of the following happens within that time:

- Any button is pressed.
- A measurement function is changed.
- Dynamic recording is enabled.
- 1 ms peak hold is enabled.
- Auto power-off mode is disabled in the setup mode.

To reactivate the clamp meter after auto power-off, simply press any button.

To disable auto power-off mode, select *OFF*. When the auto power-off mode is disabled, @OFF in the annunciator display will be turned off. The clamp meter will remain turned on until you manually turn the rotary switch to the *OFF* position.

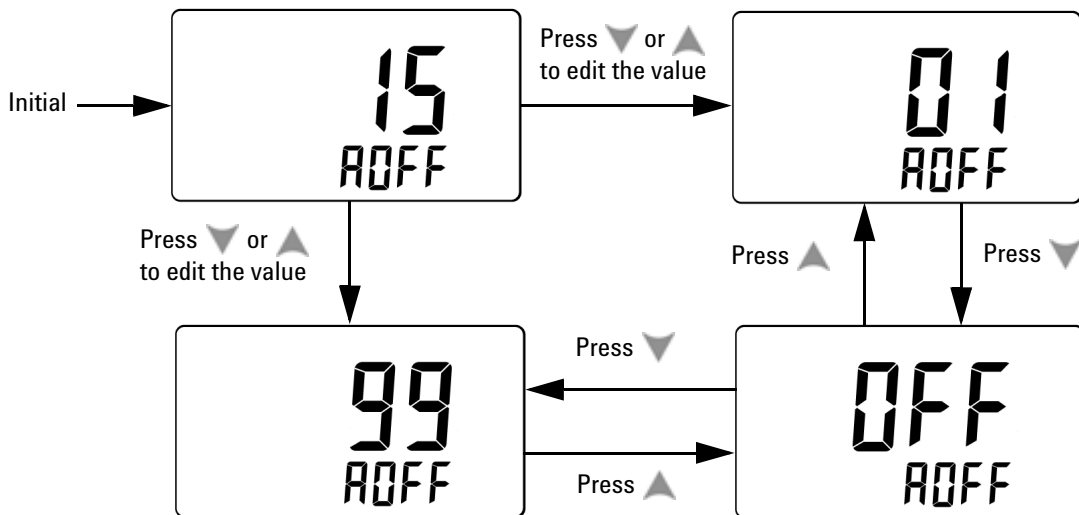

Figure 4-4 Setting the auto power-off duration

Setting backlight power-on duration

The backlight timer can be set from 1 to 99 seconds. The backlight turns off automatically after the set period.

OFF means the backlight will not turn off automatically.

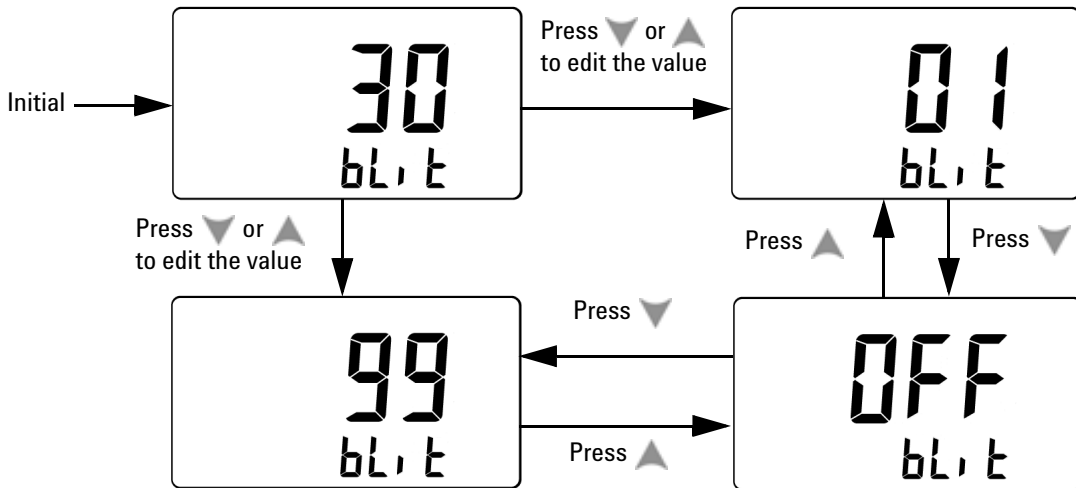

Figure 4-5 Setting the backlight power-on duration

Setting temperature unit

To set the temperature unit, press **Range/Auto** for more than 1 second when you are in setup mode. Four combinations of displayed unit(s) are available:

- Celcius only: °C single display.
- Celcius/Fahrenheit: °C/°F dual display; °C on primary, and °F on secondary.

- Fahrenheit only: °F single display.
- Fahrenheit/Celcius: °F/°C dual display; °F on primary, and °C on secondary.

NOTE

Always set the temperature unit display for official requirements and comply with national law and standards.

4 Changing the Default Settings

Default Factory Settings and Available Setting Options

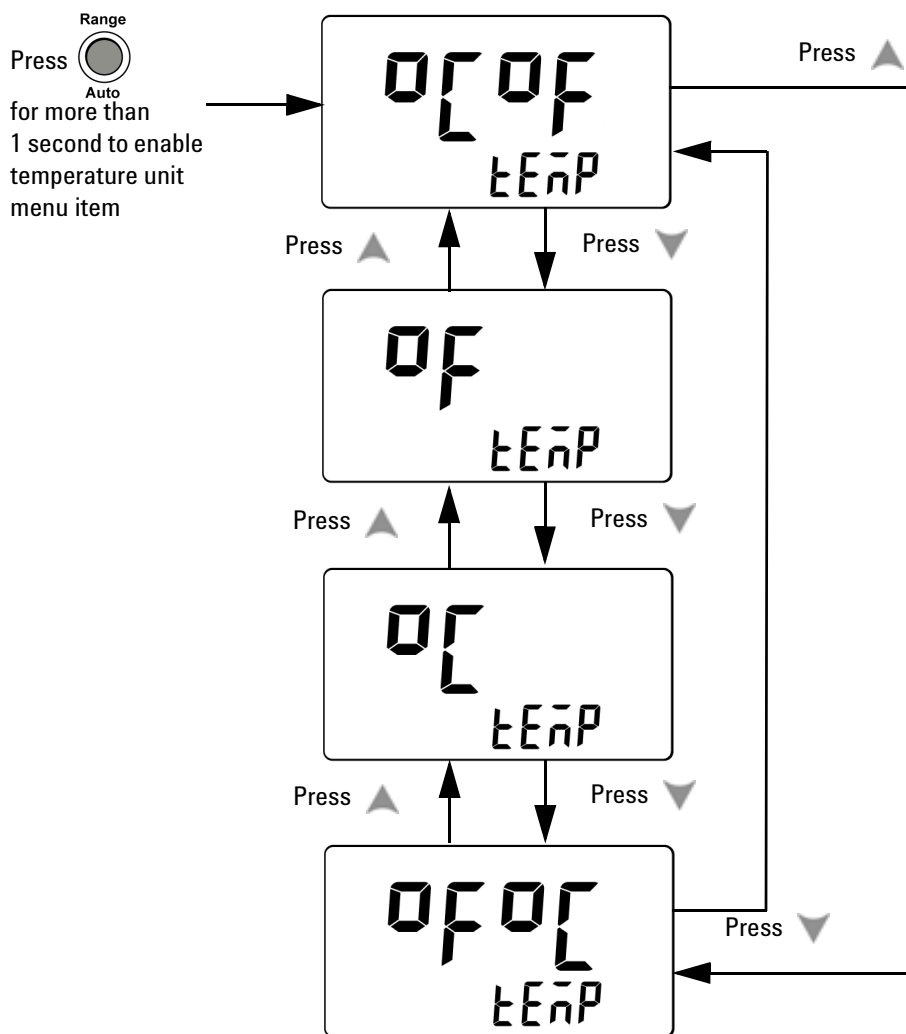

Figure 4-6 Setting the temperature unit

Returning to default factory settings

No other options are available in this menu item. Press **Hold/Max Min** to reset to default factory settings.

The reset menu item automatically reverts to minimum frequency settings menu item.

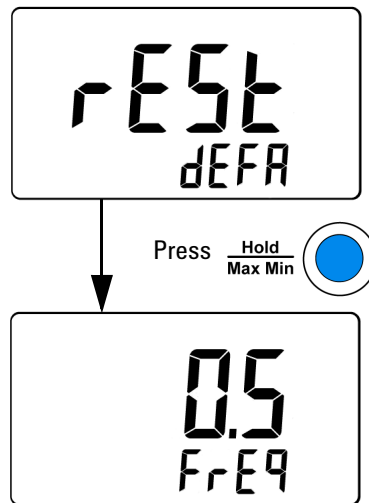

Figure 4-7 Reverting to default factory settings

4 Changing the Default Settings

Default Factory Settings and Available Setting Options



5 Maintenance

General Maintenance	78
Battery replacement	79
Troubleshooting	81
Replacement Parts	82

This chapter will help you troubleshoot malfunctioning U1211A, U1212A, and U1213A Clamp Meters.

CAUTION

Any repair or service which is not covered in this manual should only be performed by qualified personnel.



General Maintenance

WARNING

Ensure that terminal connections are correct for a particular measurement before making the measurement. To avoid damaging the device, do not exceed the rated input limit.

Dirt or moisture in the terminals can distort readings. Cleaning procedures are as follows:

- 1 Turn the clamp meter off and remove the test leads.
- 2 Turn the clamp meter over and shake out any dirt that may have accumulated in the terminals.
- 3 Wipe the case with a damp cloth and mild detergent – do not use abrasives or solvents.

Battery replacement

WARNING

The battery must be recycled or disposed off properly after depletion.

CAUTION

To avoid instruments being damage from battery leakage:

- Always remove dead batteries immediately.
 - Always remove the batteries and store them separately if the clamp meter is not going to be used for a long period.
-

The clamp meter is powered by a 9 V alkaline battery. To ensure that the clamp meter performs as specified, it is recommended that you replace the battery as soon as the low battery indicator is displayed in the annunciator display. The procedures for battery replacement are as follows:

- 1 Set the rotary switch to off.
- 2 Disconnect test leads from the input terminal.
- 3 Loosen the screw on the battery cover.
- 4 Lift the battery cover slightly, then pull the battery cover upwards.
- 5 Replace the specified battery.
- 6 Reverse the procedures above to close the cover.

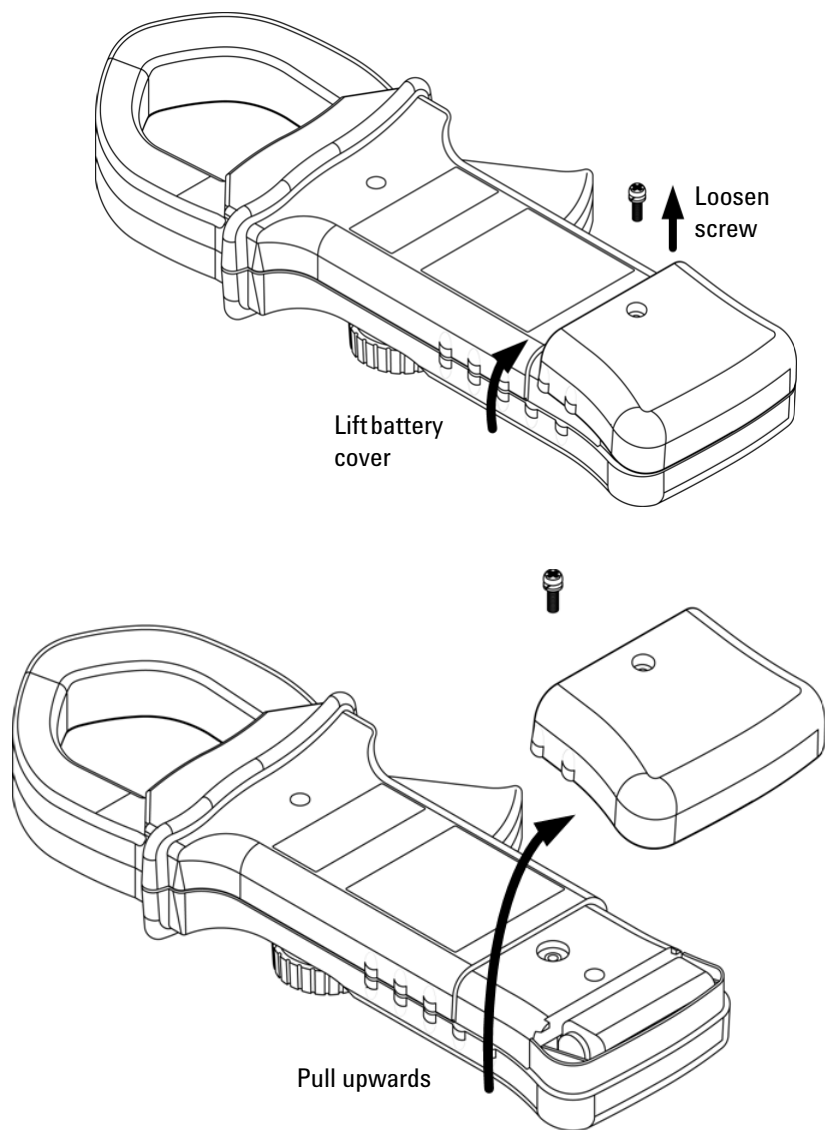

Figure 5-1 Replacing the battery in the clamp meter

Troubleshooting

WARNING

To avoid electrical shock, do not perform any servicing unless you are qualified to do so.

If the clamp meter fails to operate, check the battery and test leads. Replace them if necessary. After that, if the instrument still does not function, check to ensure that you have followed the operating procedures given in this instruction manual, before considering servicing the clamp meter.

When servicing the instrument, use only the specified replacement parts.

Table 5-1 will assist you in identifying some basic problems.

Table 5-1 Basic troubleshooting procedures

Malfunction	Troubleshooting procedure
No annunciator display after switching on	Check battery. Replace battery if necessary.
No beeper tone	Check the setup mode menu to verify whether the beeper function has been set to off. If so, select the desired driving frequency.

Replacement Parts

This section contains information for ordering replacement parts for your U1211A, U1212A, and U1213A Clamp Meters. [Table 5-2](#) includes a brief description of each replacement part with its corresponding part number.

NOTE

You may find the latest U1211A, U1212A, and U1213A Clamp Meters parts list in the Agilent Test and Measurements Parts Catalog (<http://www.agilent.com/find/parts>)

To order replacement parts

NOTE

Not all parts listed are available as field-replaceable parts.

To order replacement parts from Agilent:

- 1 Contact your nearest Agilent Sales Office or Service Center.
- 2 Identify the parts by their corresponding Agilent part numbers shown in the replacement parts list.
- 3 Provide the instrument model number and serial number.

Table 5-2 Replacement parts list

Part number	Description
U1211-46401	Battery cover with IR port (without screw)
5022-6693	Battery cover screw



6 Performance Tests and Calibration

Calibration Overview	84
Recommended Test Equipment	86
Basic Operating Tests	87
Test Considerations	88
Performance Verification Tests	90
Calibration Security	98
Adjustment Considerations	101
Front Panel Calibration	107

This chapter contains the performance test and adjustment procedures. The performance test procedure verifies that the U1211A, U1212A, and U1213A Clamp Meters are operating within its published specifications. The adjustment procedure ensures that the clamp meter remains within the specifications until the next calibration.



Calibration Overview

This manual contains procedures for verifying the instrument performance, as well as procedures for making adjustments where necessary.

NOTE

Make sure you have read “[Test Considerations](#)” on page 88 before calibrating the instrument.

Closed-case electronic calibration

The U1211A, U1212A, and U1213A clamp meter features closed-case electronic calibration. No internal mechanical adjustments are required. The instrument calculates correction factors based upon the input reference value you set. The new correction factors are stored in the non-volatile memory until the next calibration adjustment is performed. The non-volatile EEPROM calibration memory is retained when the power is off.

Agilent Technologies calibration services

When your instrument is due for calibration, contact your local Agilent Service Center for a low-cost recalibration.

Calibration Interval

A 1-year interval is adequate for most applications. Accuracy specifications are warranted only if adjustment is made at regular calibration intervals. Accuracy specifications are not warranted beyond the 1-year calibration interval. Agilent does not recommend extending calibration intervals beyond two years for any application.

Adjustment recommendation

Specifications are only guaranteed within the period stated from the last adjustment. Agilent recommends that re-adjustment should be performed during the calibration process for best performance. This will assure that the U1211A, U1212A, and U1213A clamp meters will remain within the specifications for the next calibration interval. This criterion for the re-adjustment provides the best long-term stability.

Performance data are measured during the performance verification tests but this does not guarantee that the instrument will remain within these limits unless the adjustments are performed.

Refer to “[Adjustment count](#)” on page 115 and verify that all the adjustments have been performed.

Recommended Test Equipment

The test equipment recommended for the performance verification and adjustment procedures is listed below. If the exact instrument is not available, substitute with another calibration standard of equivalent accuracy.

Table 6-1 Recommended test equipment

Application	Recommended equipment
DC voltage	Fluke 5520A
DC current	Fluke 5520A and Fluke 5500A/COIL
AC voltage	Fluke 5520A
AC current	Fluke 5520A and Fluke 5500A/COIL
Resistance	Fluke 5520A
Capacitance	Fluke 5520A
Diode	Fluke 5520A
Temperature	Fluke 5520A
Short	Shorting plug — dual banana plug with copper wire shorting the 2 terminals

Basic Operating Tests

These operating tests are for testing the basic operation of the instrument. Repair is required if the instrument fails any of these basic operating tests.

Testing the display

Press **Hold/Max Min** while rotating the rotary switch to **~A** on the clamp meter to view all segments of the annunciator display. Compare the display with the example in [Figure 6-1](#).

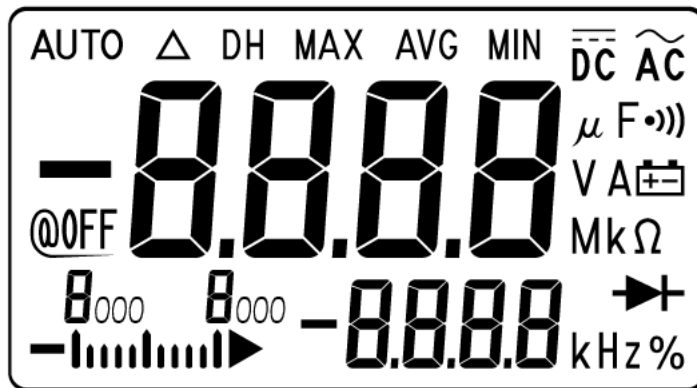

Figure 6-1 Full segments of annunciator display

Testing the backlight

Press **Hz/%/☼** for more than 1 second to carry out test on the backlight.

Test Considerations

Long test leads can also act as antennas that pick up AC signal noises.

For optimum performance, all procedures should comply with the following recommendations:

- Ensure that the ambient temperature is stable between 18 °C and 28 °C. Ideally, calibration should be performed at 23 °C ± 2 °C.
- Ensure that the ambient relative humidity is less than 80%.
- Place the clamp meter with the non-compensational transfer adapter with miniature thermal probe connected to the input terminal in the operating environment for at least 1 hour.
- Allow a 5-minute warm-up period during which a shorting plug is used to connect the **V** and **COM** input terminals.
- Use shielded twisted-pair PTFE-insulated cables to reduce settling and noise errors. Keep the input cables as short as possible.
- Connect the input cable shields to earth. Connect the calibrator LO source to earth at the calibrator, except where otherwise indicated in the procedures. It is important that the LO-to-earth connection be made at only one place in the circuit to avoid ground loops.

Please ensure that the calibration standards and test procedures used do not introduce additional errors. Ideally, the standards used to verify and adjust the instrument should be an order of magnitude more accurate than each instrument range full-scale error specification.

For DC voltage, DC current, and resistance gain verification measurements, you should ensure that the calibrator's "0" output is correct. You will need to set the offset for each range of the measurement function being verified.

Input connections

For low-thermal offset measurements, test connections to the instrument are best accomplished by shorting the two terminals using dual banana plug with copper wire short. Shielded twisted-pair PTFE interconnect cables of minimum length are recommended between the calibrator and the clamp meter. Cable shields should be grounded to earth. This configuration is recommended for optimal noise and settling time performance during calibration.

Performance Verification Tests

Use the following performance verification tests to verify the measurement performance of the U1211A, U1212A, and U1213A clamp meter. These performance verification tests are based on the specifications listed in the instrument data sheet.

These performance verification tests are recommended as acceptance tests when you first receive the instrument. After acceptance, you should repeat the performance verification tests at every calibration interval (to be performed before calibration to identify which measurement functions and ranges require calibration).

If any or all of the parameters fail the performance verification, then adjustment or repair is required.

Carry out the performance verification tests according to [Table 6-2](#) on page 91 and “[Functional tests \(only for U1212A and U1213A\)](#)” on page 95. For every listed step:

- 1 Connect the calibration standard terminals to the input terminals on the clamp meter.
- 2 Set up the calibration standard with the signals specified in the “Reference signals/values” column (one setting at a time, if more than one setting is listed).
- 3 Turn the rotary switch of the clamp meter to the function being test, and choose the correct range, as specified in the table.
- 4 Check whether the measured reading falls within the specified error limits from the reference value. If it does, then this particular function and range does not require adjustment (calibration). Otherwise, adjustment is necessary.

NOTE

When performing verification tests on current function, use Fluke 5500A/COIL with Fluke 5520A. Refer to [Table 6-1](#) on page 86 for recommended test equipment information.

Table 6-2 Performance verification tests

Test function	Range	Reference signals/values	Error limits (from nominal 1 year)		
		5520A output	U1211A	U1212A	U1213A
Temperature	–200 °C to –40 °C	–200 °C	–	±5.0 °C	±5.0 °C
	–40 °C to 1372 °C	0 °C	–	±1.0 °C	±1.0 °C
	–40 °C to 1372 °C	1372 °C	–	±14.7 °C	±14.7 °C
Resistance	400 Ω	400 Ω	±2.3 Ω	±2.3 Ω	±1.5 Ω
	4 kΩ	4 kΩ	±0.023 kΩ	±0.024 kΩ	±0.015 kΩ
	40 kΩ	40 kΩ	–	–	±0.15 kΩ
	400 kΩ	400 kΩ	–	–	±1.5 kΩ
	4 MΩ	4 MΩ	–	–	±0.027 MΩ
	40 MΩ	40 MΩ	–	–	±0.85 MΩ
Diode	Diode	1.9 V	±0.012 V	±0.012 V	±0.012 V
Capacitance	4 μF	4 μF	–	–	±0.044 μF
	40 μF	40 μF	–	–	±0.44 μF
	400 μF	400 μF	±8.4 μF	±8.4 μF	±8.4 μF
	4000 μF	4000 μF	±124 μF	±124 μF	±124 μF
DC voltage	4 V	4 V	–	–	±0.011 V
	40 V	40 V	–	–	±0.11 V
	400 V	400 V	±2.3 V	±2.3 V	±1.1 V
	1000 V	1000 V	±8 V	±8 V	±8 V

6 Performance Tests and Calibration

Performance Verification Tests

Table 6-2 Performance verification tests (continued)

Test function	Range	Reference signals/values	Error limits (from nominal 1 year)		
		5520A output	U1211A	U1212A	U1213A
AC voltage	4 V	4 V, 45 Hz	–	–	±0.045 V
		4 V, 2 kHz	–	–	±0.085 V
	40 V	40 V, 45 Hz	–	–	±0.45 V
		40 V, 2 kHz	–	–	±0.85 V
	400 V	400 V, 45 Hz	±4.5 V	±4.5 V	±4.5 V
		400 V, 400 Hz	±4.5 V	±4.5 V	–
		400 V, 2 kHz	–	–	±8.5 V
	1000 V	1000 V, 45 Hz	±15 V	±15 V	±15 V
		1000 V, 400 Hz	±15 V	±15 V	–
1000 V, 2 kHz		–	–	±25 V	
Peak voltage (max)	400 V	400 V _p , 60 Hz	±8.3 V	±8.3 V	±8.3 V
Frequency	99.99 Hz	10 Hz, 0.6 V	–	–	±0.05 Hz
	9.999 kHz	2 kHz, 20 V	±0.007 kHz	±0.007 kHz	–
Duty cycle	0.1% to 99.9%	5 V _{pp} at 50%, square wave, 2 kHz	–	–	±0.9 %
AC + DC voltage ^[2]	4 V	4 V, 45 Hz	–	–	±0.069 V
		4 V, 2 kHz	–	–	±0.109 V
	40 V	40 V, 45 Hz	–	–	±0.69 V
		40 V, 2 kHz	–	–	±1.09 V
	400 V	400 V, 45 Hz	–	–	±6.9 V
		400 V, 2 kHz	–	–	±10.9 V
	1000 V	1000 V, 45 Hz	–	–	±24 V
		1000 V, 2 kHz	–	–	±34 V

Table 6-2 Performance verification tests (continued)

Test function	Range	5520A output use with 5500A/COIL	Reference values	Error limits (from nominal 1 year)		
				U1211A	U1212A	U1213A
DC current ^[1]	40 A	0.8 A	40 A	–	±0.75 A	±0.75 A
	400 A	8 A	400 A	–	±6.5 A	±6.5 A
	1000 A	20 A	1000 A	–	±25 A	±25 A
AC current	40 A	0.8 A, 45 Hz	40 A, 45 Hz	±0.5 A	±0.9 A	±0.9 A
		0.8 A, 100 Hz	40 A, 100 Hz	±0.5 A	±1.3 A	–
		0.8 A, 400 Hz	40 A, 400 Hz	±0.5 A	±1.3 A	±1.3 A
	400 A	8 A, 45 Hz	400 A, 45 Hz	±4.5 A	±8.5 A	±8.5 A
		0.4 A, 400 Hz	20 A, 400 Hz	±0.7 A	±1.1 A	±1.1 A
	1000 A	14 A, 45 Hz	700 A, 45 Hz	±12 A	–	–
		2.99999 A, 400 Hz	150 A, 400 Hz	±6 A	±9 A	±9 A
		20 A, 45 Hz	1000 A, 45 Hz	–	±30 A	±30 A
	AC + DC current ^[2]	40 A	0.8 A, 400 Hz	40 A, 400 Hz	–	–
400 A		0.4 A, 400 Hz	20 A, 400 Hz	–	–	±1.8 A
1000 A		1 A, 400 Hz	50 A, 400 Hz	–	–	±12 A
Peak current (max)	400 A	8 A _{peak} , 60 Hz	400 A _{peak} , 60 Hz	±12.3 A	±12.3 A	±12.3 A

[1] The measurement option is only available for U1212A and U1213A.

[2] The measurement option is only available for U1213A.

6 Performance Tests and Calibration

Performance Verification Tests

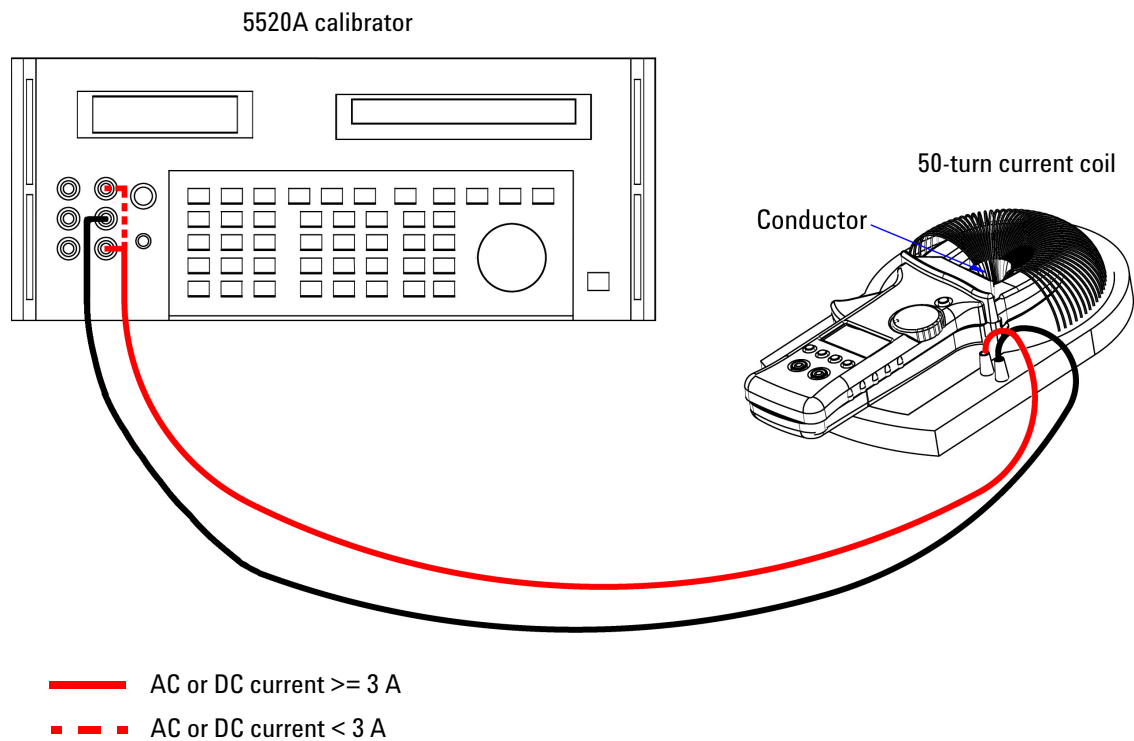

Figure 6-2 Current performance verification test setup

Functional tests (only for U1212A and U1213A)

DC current offset verification test

- 1 Place the clamp meter at a stationary position. Keep the clamp jaw closed without any conductor within the jaw.
- 2 Turn the rotary switch of the clamp meter to the DC current function.
- 3 Check whether the measured reading falls within the specified error limits from the reference value as stated in [Table 6-3](#). Otherwise, repair is recommended. Please contact Agilent Service Center for support.

NOTE

Ensure that the clamp meter is stationary when conducting the functional tests in order to get accurate readings.

Table 6-3 DC current offset verification test

Test function	Range	Reference input value	Error limits ^[1]
DC current	40 A	0 A	±0.15 A

[1] Null function turned on.

6 Performance Tests and Calibration

Performance Verification Tests

AC current balancing verification test

- 1 Place the clamp meter to a 50-turn current coil as per [Figure 6-2](#), “Current performance verification test setup,” on page 94.
- 2 Move the clamp meter to the conductor at position 1 as shown in the figure below. Ensure that the conductor position is close to the top of the jaw.

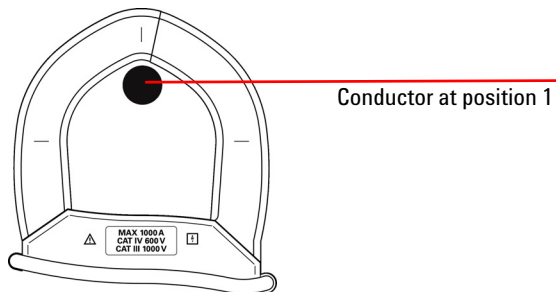

- 3 Record the current reading at position 1.
- 4 Slowly move the clamp meter so that the conductor is in position 2 as shown in the figure below. Ensure that the conductor position is close to the bottom of the jaw.

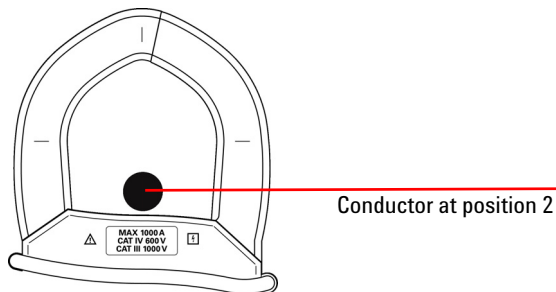

- 5 Record the current reading at position 2.
- 6 Calculate the difference between the readings at position 1 and position 2. Check whether the difference falls within the specified error limits in [Table 6-4](#). Otherwise, repair is recommended. Please contact Agilent Service Center for support.

Table 6-4 AC current balancing verification test

Test function	Range	5520A output use with 5500A/COIL	Reference values	Error limits (Difference between reading at position 1 and position 2)
AC current	400 A	6 A, 50 Hz	300 A, 50 Hz	± 0.5 A

Calibration Security

A calibration security code is in place to prevent accidental or unauthorized adjustments to the instrument. When you first receive your instrument, it is secured. Before you can adjust the instrument, you must “unsecure” it by entering the correct security code (see [“Unsecuring the instrument for calibration”](#) on page 98).

The security code is set as 1234 when the instrument is shipped from the factory. The security code is stored in non-volatile memory, which does not change even when the power is off.

NOTE

You can unsecure the instrument and then change the security code from the front panel or through the remote interface.

The security code may contain up to 4 numeric characters.

NOTE

See [“Resetting the security code to factory default”](#) on page 100 if you forget your security code.

Unsecuring the instrument for calibration

Before you can adjust the instrument, you must unsecure it by entering the correct security code. The security code is set to 1234 when the instrument is shipped from the factory. The security code is stored in non-volatile memory, and does not change when the power is turned off.

NOTE

See [Table 4-1](#) on page 64 for the directional button operations to be used in the subsequent procedures below.

Unsecuring the instrument

- 1 Press **Range/Auto** for more than 1 second while rotating the rotary switch to **~A** on the clamp meter to enter the Calibration Security Code entry mode.
- 2 The annunciator primary display will indicate “5555” and the annunciator secondary display will indicate “SECU”.
- 3 Press **Range/Auto** again to edit and enter security code.
- 4 Press ▼ or ▲ (refer to [Table 4-1](#) on page 64) to step each character in the code. Press ◀ or ▶ (refer to [Table 4-1](#) on page 64) to select each character.
- 5 Press **Hold/Max Min** when done. If the correct security code is entered, the secondary display will indicate “PASS”.

Changing the instrument Calibration Security Code

- 1 When the meter is in the unsecured mode, press **Range/Auto** for more than 1 second to enter the Calibration Security Code setting mode.
- 2 The primary display shows the current security code and the secondary display shows “CHG”

NOTE

The factory default calibration security code 1234 will be displayed on the primary display if this is the first time to change the security code.

- 3 Press ▼ or ▲ to step each character in the code.
- 4 Press ◀ or ▶ to change each character in the code.
- 5 Press **Hold/Max Min** to store the new calibration security code. If the new security code is successfully stored, the secondary display will indicate “PASS”.

Resetting the security code to factory default

If you have forgotten the correct security code, you may follow the steps below to change the security code back to the factory default (1234).

- 1 Record the last 4 digits of the clamp meter serial number.
- 2 Press **Range/Auto** for more than 1 second while rotating the rotary switch to **~A** on the clamp meter to enter Calibration Security Code entry mode.
- 3 The annunciator primary display will indicate “5555” and the annunciator secondary display will indicate “SECU”.
- 4 Press **Range/Auto** for more than 1 second to enter the Set Default Security Code mode.
- 5 The annunciator secondary display will indicate “SEri” and the annunciator primary display will indicate “5555”.
- 6 Press ▼ or ▲ to step each character in the code. Press ◀ or ▶ to select each character.
- 7 Set the code, similar to the last 4 digits of the instrument serial number
- 8 Press **Hold/Max Min** to confirm the entry.
- 9 If the 4 digits entered are correct, the secondary display will indicate “PASS”.

Now you can use 1234 as the security code. If you want to enter a new security code, see [“Changing the instrument Calibration Security Code”](#) on page 99. Ensure you record the new security code.

Adjustment Considerations

To adjust the instrument, you will need a test input cable, connectors set, and a shorting plug (see [“Input connections”](#) on page 89).

NOTE

After each adjustment, the secondary display briefly shows “PASS”. If the calibration fails, the clamp meter sounds a beep, and an error number is shown in the secondary display. Calibration error messages are described in [“Error Codes”](#) on page 117. In the event of a calibration failure, correct the problem and repeat the procedure.

Adjustment for each function should be performed with the following considerations (where applicable):

- 1 Allow the instrument to warm up and stabilize for 5 minutes before performing the adjustments.
- 2 Ensure that during the adjustment, the low-battery indicator does not appear. Replace the battery as soon as possible to avoid false reading.
- 3 Consider thermal effects as you connect test leads to the calibrator and this instrument. It is recommended that you wait for 1 minute after connecting the test leads before you begin the calibration.
- 4 During ambient temperature adjustment, ensure that the instrument has been turned on for at least 1 hour with the K-type thermocouple connected between the instrument and the calibration source.

CAUTION

Never turn off the instrument during calibration. This may delete the calibration memory for the present function.

Valid adjustment reference input values

Adjustments can be performed using the following reference input values:

Table 6-5 U1211A valid adjustment reference input values

Function	Range	Reference input value	Valid range for reference input
DC voltage	Short	SHORT	Short V and COM terminals
	400 V	300.0 V	0.9 to 1.1 × reference input value
	1000 V	1000 V	0.9 to 1.1 × reference input value
AC voltage	400 V	030.0 V (70 Hz)	0.9 to 1.1 × reference input value
		300.0 V (70 Hz)	0.9 to 1.1 × reference input value
		300.0 V (2 kHz)	0.9 to 1.1 × reference input value
	1000 V	100 V (70 Hz)	0.9 to 1.1 × reference input value
		1000 V (70 Hz)	0.9 to 1.1 × reference input value
		1000 V (2 kHz)	0.9 to 1.1 × reference input value
AC current	40 A	02.00 A (70 Hz)	0.9 to 1.1 × reference input value
		30.00 A (70 Hz)	0.9 to 1.1 × reference input value
	400 A	030.0 A (70 Hz)	0.9 to 1.1 × reference input value
		300.0 A (70 Hz)	0.9 to 1.1 × reference input value
	1000 A	50 A (70 Hz)	0.9 to 1.1 × reference input value
		300 A (70 Hz)	0.9 to 1.1 × reference input value
Resistance	Short	SHORT	Short Ω and COM terminals
	4 k Ω	3.000 k Ω	0.9 to 1.1 × reference input value
	400 Ω	300.0 Ω	0.9 to 1.1 × reference input value
Capacitance	400 μ F	300.0 μ F	0.9 to 1.1 × reference input value
	4000 μ F	3000 μ F	0.9 to 1.1 × reference input value
Diode	Short	SHORT	0 Ω
	2.000 V	2.000 V	0.9 to 1.1 × reference input value

Table 6-6 U1212A valid adjustment reference input values

Function	Range	Reference input value	Valid range for reference input
DC voltage	Short	SHORT	Short V and COM terminals
	400 V	300.0 V	0.9 to 1.1 × reference input value
	1000 V	1000 V	0.9 to 1.1 × reference input value
AC voltage	400 V	030.0 V (70 Hz)	0.9 to 1.1 × reference input value
		300.0 V (70 Hz)	0.9 to 1.1 × reference input value
		300.0 V (2 kHz)	0.9 to 1.1 × reference input value
	1000 V	100 V (70 Hz)	0.9 to 1.1 × reference input value
		1000 V (70 Hz)	0.9 to 1.1 × reference input value
		1000 V (2 kHz)	0.9 to 1.1 × reference input value
DC current	Open	OPEN	Keep jaw closed without conductor
	40 A	30 A	0.9 to 1.1 × reference input value
	400 A	300 A	0.9 to 1.1 × reference input value
	1000 A	300 A	0.9 to 1.1 × reference input value
AC current	40 A	02.00 A (70 Hz)	0.9 to 1.1 × reference input value
		30.00 A (70 Hz)	0.9 to 1.1 × reference input value
	400 A	030.0 A (70 Hz)	0.9 to 1.1 × reference input value
		300.0 A (70 Hz)	0.9 to 1.1 × reference input value
	1000 A	50 A (70 Hz)	0.9 to 1.1 × reference input value
		300 A (70 Hz)	0.9 to 1.1 × reference input value
Resistance	Short	SHORT	Short Ω and COM terminals
	4 k Ω	3.000 k Ω	0.9 to 1.1 × reference input value
	400 Ω	300.0 Ω	0.9 to 1.1 × reference input value
Capacitance	400 μ F	300.0 μ F	0.9 to 1.1 × reference input value
	4000 μ F	3000 μ F	0.9 to 1.1 × reference input value

6 Performance Tests and Calibration

Adjustment Considerations

Table 6-6 U1212A valid adjustment reference input values (continued)

Function	Range	Reference input value	Valid range for reference input
Temperature	Short	SHORT	Short V and COM terminals
	0.4 V	0.400 V	0.9 to 1.1 × reference input value
	K-type	000.0 °C	Provide 0 °C with ambient compensation
Diode	Short	SHORT	0 Ω
	2.000 V	2.000 V	0.9 to 1.1 × reference input value

Table 6-7 U1213A valid adjustment reference input values

Function	Range	Reference input value	Valid range for reference input
DC voltage	Short	SHORT	Short V and COM terminals
	4 V	3.000 V	0.9 to 1.1 × reference input value
	40 V	30.00 V	0.9 to 1.1 × reference input value
	400 V	300.0 V	0.9 to 1.1 × reference input value
	1000 V	1000 V	0.9 to 1.1 × reference input value

Table 6-7 U1213A valid adjustment reference input values (continued)

Function	Range	Reference input value	Valid range for reference input
AC voltage	4 V	0.200 V (70 Hz)	0.9 to 1.1 × reference input value
		3.000 V (70 Hz)	0.9 to 1.1 × reference input value
		3.000 V (2 kHz)	0.9 to 1.1 × reference input value
	40 V	030.0 V (70 Hz)	0.9 to 1.1 × reference input value
		30.00 V (70 Hz)	0.9 to 1.1 × reference input value
		30.00 V (2 kHz)	0.9 to 1.1 × reference input value
	400 V	030.0 V (70 Hz)	0.9 to 1.1 × reference input value
		300.0 V (70 Hz)	0.9 to 1.1 × reference input value
		300.0 V (2 kHz)	0.9 to 1.1 × reference input value
	1000 V	100 V (70 Hz)	0.9 to 1.1 × reference input value
		1000 V (70 Hz)	0.9 to 1.1 × reference input value
		1000 V (2 kHz)	0.9 to 1.1 × reference input value
DC current	Open	OPEN	Keep jaw closed without conductor
	40 A	30 A	0.9 to 1.1 × reference input value
	400 A	300 A	0.9 to 1.1 × reference input value
	1000 A	300 A	0.9 to 1.1 × reference input value
AC current	40 A	02.00 A (70 Hz)	0.9 to 1.1 × reference input value
		30.00 A (70 Hz)	0.9 to 1.1 × reference input value
	400 A	030.0 A (70 Hz)	0.9 to 1.1 × reference input value
		300.0 A (70 Hz)	0.9 to 1.1 × reference input value
	1000 A	50 A (70 Hz)	0.9 to 1.1 × reference input value
		300 A (70 Hz)	0.9 to 1.1 × reference input value

6 Performance Tests and Calibration

Adjustment Considerations

Table 6-7 U1213A valid adjustment reference input values (continued)

Function	Range	Reference input value	Valid range for reference input
Resistance	Short	SHORT	Short Ω and COM terminals
	10 M Ω	OPEN	Open terminals
		10.000 M Ω	0.9 to 1.1 \times reference input value
	400 k Ω	300.0 k Ω	0.9 to 1.1 \times reference input value
	40 k Ω	30.00 k Ω	0.9 to 1.1 \times reference input value
	4 k Ω	3.000 k Ω	0.9 to 1.1 \times reference input value
400 Ω	300.0 Ω	0.9 to 1.1 \times reference input value	
Capacitance	Open	OPEN	Open terminals
	4 μ F	0.300 μ F	0.9 to 1.1 \times reference input value
		3.000 μ F	0.9 to 1.1 \times reference input value
	40 μ F	30.00 μ F	0.9 to 1.1 \times reference input value
	400 μ F	300.0 μ F	0.9 to 1.1 \times reference input value
4000 μ F	3000 μ F	0.9 to 1.1 \times reference input value	
Diode	Short	SHORT	0 Ω
Temperature	2.000 V	2.000 V	0.9 to 1.1 \times reference input value
	Short	SHORT	Short V and COM terminals
	0.4 V	0.400 V	0.9 to 1.1 \times reference input value
	K-type	000.0 $^{\circ}$ C	Provide 0 $^{\circ}$ C with ambient compensation

Front Panel Calibration

Calibration process

The following general procedure is the recommended method to complete a full instrument calibration:

- 1 Read “[Test Considerations](#)” on page 88.
- 2 Perform the verification tests to characterize the instrument (incoming data).
- 3 Unsecure the instrument calibration (see “[Calibration Security](#)” on page 98).
- 4 Perform the adjustment procedures (see “[Adjustment Considerations](#)” on page 101).
- 5 Secure the instrument against calibration.
- 6 Note the new security code and calibration count in the instrument maintenance records.

NOTE

Make sure that you quit the adjustment mode before turning off the clamp meter.

Adjustment procedures

The calibration procedures are shown as follows:

- 1 Press **Range/Auto** for more than 1 second while rotating the rotary switch to the function you wish to adjust.
- 2 Unsecure the clamp meter. Refer to “[Unsecuring the instrument for calibration](#)” on page 98.
- 3 After verifying that the security code entered is correct, the instrument will indicate the reference input value of the adjustment item on the primary display after briefly showing “PASS” on the secondary display.
- 4 Set up the indicated reference input and apply this input to the correct terminals of the clamp meter. For example:

6 Performance Tests and Calibration

Front Panel Calibration

- If the required reference input is “SHORT”, use a shorting plug to short the two relevant terminals.
 - If the required reference input is “OPEN”, just leave the terminals open.
 - If the required reference input is a voltage, current, resistance, capacitance, or temperature value, set up the Fluke 5520A calibrator (or another device with equivalent standard of accuracy) to provide the necessary input.
- 5 With the required reference input applied to the correct terminals, press **Hold/Max Min** to start the present adjustment item.
 - 6 During calibration, the primary display and bar-graph will indicate the uncalibrated reading, and the calibration indicator, “CAL”, will appear on the secondary display. If the reading is within the acceptable range, the word “PASS” will be shown momentarily, and then the instrument will proceed to the next adjustment item. If the reading is out of the acceptable range, it will remain at the present adjustment item after showing the error code for 3 seconds. In this case, you need to check whether the correct reference input has been applied. Refer to [“Error codes and their respective meanings”](#) on page 117 for the meaning of the error codes.
 - 7 Repeat step 4 and step 5 until all the adjustment items for the particular function have been completed.
 - 8 Select another function to be calibrated. Repeat step 4 to step 7. For a rotary switch position that hosts more than one function, for example,  Ω , press **Shift/Peak** to go to the next function.
 - 9 After calibrating all the functions, switch off the instrument and then switch it on again. The instrument will be back to normal measurement mode.

You may also refer to [“Typical adjustment process flow”](#) on page 109.

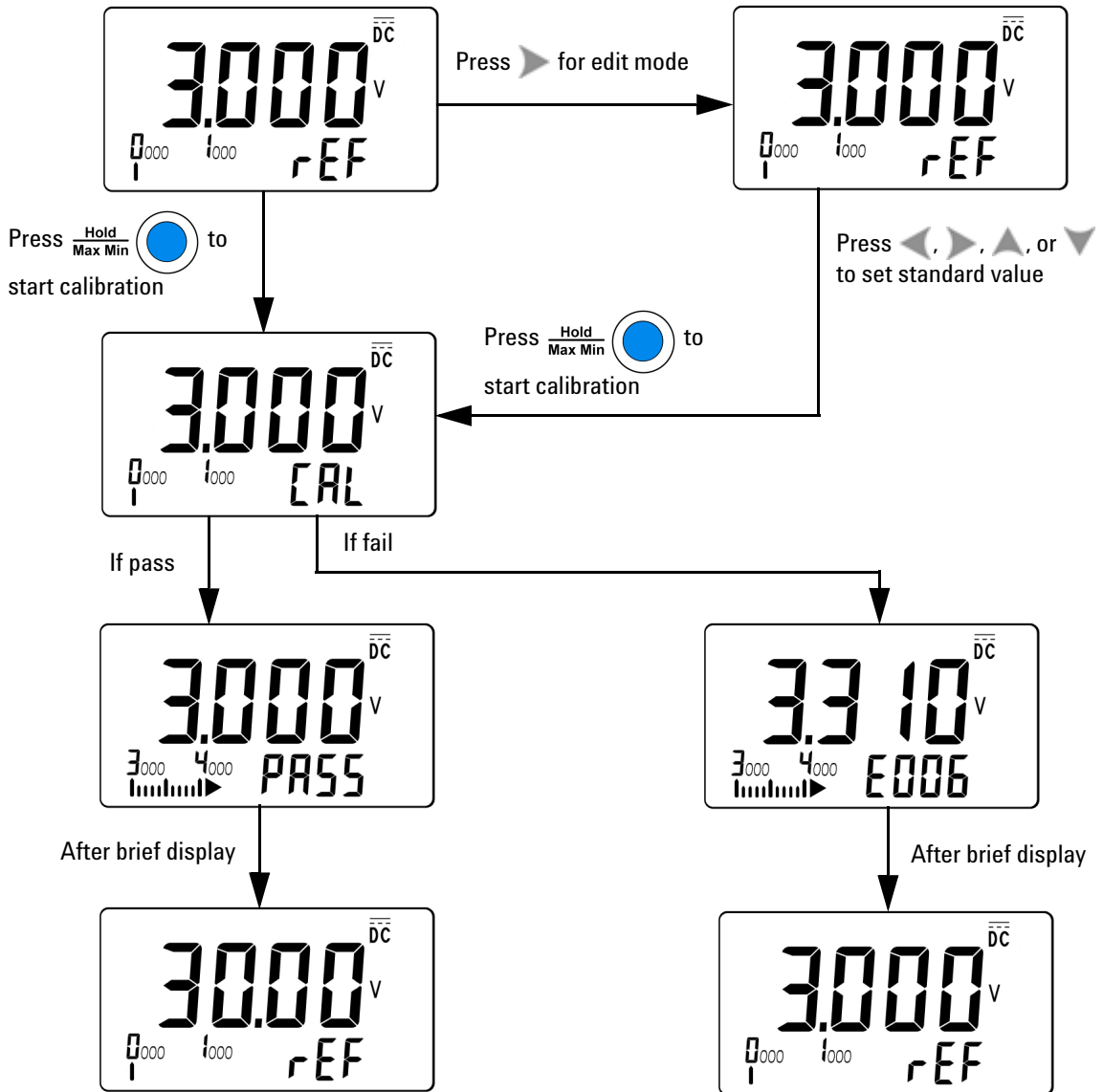

Figure 6-3 Typical adjustment process flow

6 Performance Tests and Calibration

Front Panel Calibration

Selecting the adjustment mode

To unsecure the instrument, see “Unsecuring the instrument for calibration” on page 98 or “Resetting the security code to factory default” on page 100. Once unsecured, the reference value will be indicated on the primary display.

Entering adjustment values

Use the following adjustment procedure to enter an input calibration value from the front panel:

- 1 Press ◀ or ▶ (refer to Table 4-1 on page 64) to select each digit in the primary display.
- 2 Press ▼ or ▲ (refer to Table 4-1 on page 64) to advance through the digits 0 to 9.
- 3 Press **Hold/Max Min** when you are done.

Verify the adjustments using Table 6-8 for U1211A, Table 6-9 for U1212A, and Table 6-10 for U1213A.

Table 6-8 U1211A list of adjustment items

Function	Range	Adjustment item
AC voltage	400 V	30.00 V (70 Hz)
		300.00 V (70 Hz)
		300.00 V (2 kHz)
	1000 V	100.0 V (70 Hz)
		1000.0 V (70 Hz)
		1000.0 V (2 kHz)
DC voltage	SHrt	Short
	400 V	300.0 V
	1000 V	1000 V

Table 6-8 U1211A list of adjustment items (continued)

Function	Range	Adjustment item
AC current	40 A	02.00 A (70 Hz)
		30.00 A (70 Hz)
	400 A	030.0A (70 Hz)
		300.0 A (70 Hz)
	1000 A	50 A (70 Hz)
		300 A (70 Hz)
Resistance	Short	SHrt
	4 k Ω	3.000 k Ω
	400 Ω	300.0 Ω
Capacitance	400 μ F	300.0 μ F
	4000 μ F	3000 μ F
Diode	Short	0 Ω
	2.000 V	2.000 V

Table 6-9 U1212A list of adjustment items

Function	Range	Adjustment item
AC voltage	400 V	30.00 V (70 Hz)
		300.00 V (70 Hz)
		300.00 V (2 kHz)
	1000 V	100.0 V (70 Hz)
		1000.0 V (70 Hz)
		1000.0 V (2 kHz)

6 Performance Tests and Calibration

Front Panel Calibration

Table 6-9 U1212A list of adjustment items (continued)

Function	Range	Adjustment item
DC voltage	SHrt	Short
	400 V	300.0 V
	1000 V	1000 V
AC current	40 A	02.00 A (70 Hz)
		30.00 A (70 Hz)
	400 A	030.0 A (70 Hz)
		300.0 A (70 Hz)
	1000 A	50 A (70 Hz)
		300 A (70 Hz)
DC current	Open	oPEn
	40 A	30 A
	400 A	300 A
	1000 A	300 A
Resistance	Short	SHrt
	4 k Ω	3.000 k Ω
	400 Ω	300.0 Ω
Capacitance	400 μ F	300.0 μ F
	4000 μ F	3000 μ F
Temperature	Short	SHrt
	0.400 V	0.400 V
	K-type	000.0 $^{\circ}$ C
Diode	Short	0 Ω
	2.000 V	2.000 V

Table 6-10 U1213A list of adjustment items

Function	Range	Adjustment item
AC voltage	4 V	0.200 V (70 Hz)
		3.000 V (70 Hz)
		3.000 V (2 kHz)
	40 V	03.00 V (70 Hz)
		30.00 V (70 Hz)
		30.00 V (2 kHz)
	400 V	30.00 V (70 Hz)
		300.00 V (70 Hz)
		300.00 V (2 kHz)
	1000 V	100.0 V (70 Hz)
		1000.0 V (70 Hz)
		1000.0 V (2 kHz)
DC voltage	SHrt	Short
	4 V	3.000 V
	40 V	30.00 V
	400 V	300.0 V
	1000 V	1000 V
AC current	40 A	02.00 A (70 Hz)
		30.00 A (70 Hz)
	400 A	030.0 A (70 Hz)
		300.0 A (70 Hz)
	1000 A	50 A (70 Hz)
		300 A (70 Hz)

6 Performance Tests and Calibration

Front Panel Calibration

Table 6-10 U1213A list of adjustment items (continued)

Function	Range	Adjustment item
DC current	Open	oPEn
	40 A	30 A
	400 A	300 A
	1000 A	300 A
Resistance	Short	SHrt
	10 M Ω	Open
	400 k Ω	300.0 k Ω
	40 k Ω	30.00 k Ω
	4 k Ω	3 k Ω
Capacitance	Open	oPEn
	4 μ F	0.300 μ F
		3.000 μ F
	40 μ F	30.00 μ F
	400 μ F	300.0 μ F
4000 μ F	3000 μ F	
Temperature	Short	SHrt
	0.400 V	0.400 V
	K-type	000.0 $^{\circ}$ C
Diode	Short	0 Ω
	2.000 V	2.000 V

Adjustment count

The adjustment count feature provides an independent “serialization” of your adjustments. With it, you can determine the number of times your instrument has been adjusted. By monitoring the adjustment count, you can tell whether an unauthorized adjustment has been performed. The value increments by one each time instrument is adjusted.

The adjustment count is stored in a non-volatile EEPROM memory, the contents of which do not change even after the instrument is switched off. Your clamp meter had been adjusted before leaving the factory. When you receive your clamp meter, make sure to read the adjustment count for the first time and record it for maintenance purpose.

The adjustment count increases up to a maximum of 9999, after which it wraps around to 0. There is no way to program or reset the adjustment count. It is an independent electronic “serialization” value.

To view the present adjustment count, unsecure the instrument (see [“Unsecuring the instrument for calibration”](#) on page 98), and then press **Shift/Peak** for more than 1 second to view the adjustment count. Press **Shift/Peak** for more than 1 second again to exit the adjustment count display.

6 Performance Tests and Calibration

Front Panel Calibration

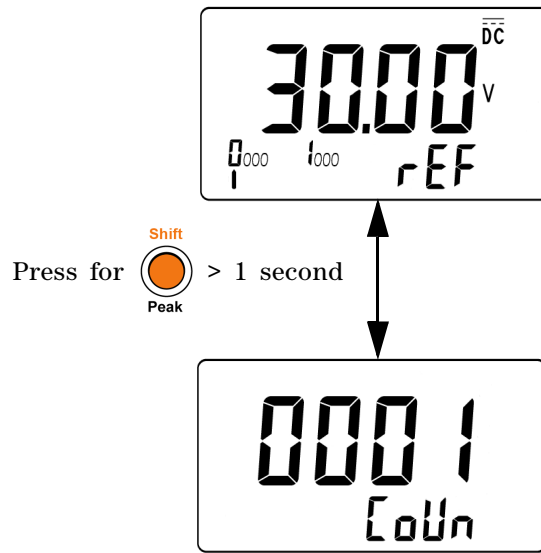

Figure 6-4 Displaying adjustment counts

Error Codes

Table 6-11 below lists the various error codes for the calibration process.

Table 6-11 Error codes and their respective meanings

Error code	Description
E002	Secure code invalid
E003	Serial number code invalid
E004	Calibration aborted
E005	Value out of range
E006	Signal measurement out of range
E007	Frequency out of range
E008	EEPROM write failure

6 Performance Tests and Calibration

Front Panel Calibration



7 Characteristics and Specifications

Product Characteristics	120
U1211A Electrical Specifications	122
U1212A Electrical Specifications	127
U1213A Electrical Specifications	134

This chapter specifies the characteristics, environmental conditions, and specifications of the U1211A, U1212A, and U1213A Clamp Meters.



Product Characteristics

Table 7-1 Product characteristics

DIMENSIONS (W × L × H)

- 106 mm × 273 mm × 43 mm for U1211A
- 106 mm × 260 mm × 43 mm for U1212A and U1213A

WEIGHT

- 605 g with battery for U1211A
- 525 g with battery for U1212A and U1213A

DISPLAY

Both primary and secondary displays are 4-digit liquid crystal display (LCD) with maximum reading of 4500 counts. Twelve-segment analog bar graph and full annunciator. Automatic polarity indication.

BATTERY TYPE

- 9 V alkaline battery (ANSI/NEDA 1604A or IEC 6LR61)
- 9 V carbon-zinc battery (ANSI/NEDA 1604D or IEC 6F22)

TYPICAL BATTERY LIFE (without backlight)

- 60 hours for DC voltage measurement
- 50 hours for maximum power consumption (for U1211A)
- 36 hours for maximum power consumption (for U1212A and U1213A)

POWER CONSUMPTION

- 186 mVA maximum for U1211A
- 220 mVA maximum for U1212A and U1213A

MAXIMUM JAW OPENING

2 inches

TEMPERATURE COEFFICIENT

0.1% × (specified accuracy)/°C (from 0 °C to 18 °C or 28 °C to 50 °C)

COMMON MODE REJECTION RATIO (CMRR)

- More than 60 dB at DC to 60 Hz for AC Voltage
- More than 80 dB (for U1211A and U1212A) and more than 120 dB (for U1213A) at DC, 50 Hz and 60 Hz for DC Voltage

NORMAL MODE REJECTION RATIO (NMRR)

More than 60 dB at 50 Hz and 60 Hz

Table 7-1 Product characteristics (continued)

OPERATING ENVIRONMENT

- Operating temperature from –10 °C to 50 °C
- Relative humidity up to 80 % for temperature up to 31 °C, decreasing linearly to 50% R.H. at 50 °C
- Altitude up to 2000 meters

STORAGE ENVIRONMENT

- Storage temperature from –20 °C to 60 °C, with battery removed
- Relative humidity up to 80% R.H. noncondensing

SAFETY COMPLIANCE

- IEC/EN 61010-1:2001
- IEC/EN 61010-2-032:2002
- ANSI/UL 61010-1:2004
- CAN/CSA-C22.2 No.61010-1-04
- CAN/CSA-C22.2 No.61010-1-032-04
- Pollution Degree II

EMC COMPLIANCE

- IEC 61326-1:2005/EN 61326-1:2006
- CISPR 11:2003/EN 55011:2007 (Group 1 Class A)
- Canada: ICES/NMB-001:2004
- Australia/New Zealand: AS/NZS CISPR 11:2004

MEASUREMENT CATEGORY

- CAT III, 1000 V
- CAT IV, 600 V

WARRANTY

- Please refer to http://www.agilent.com/go/warranty_terms
 - Three years for the product
 - Three months for the product's standard accessories, unless otherwise specified
 - Please take note that for the product, the warranty does not cover:
 - Damage from contamination
 - Normal wear and tear of mechanical components
 - Manuals and standard disposable batteries
-

U1211A Electrical Specifications

The accuracy is given as \pm (% of reading + number of least significant digit) at 23 °C \pm 5 °C, with relative humidity less than 80% R.H.

DC specifications

Table 7-2 U1211A DC accuracy \pm (% of reading + number of LSD)

Function	Range	Resolution	Accuracy	Test current or burden voltage
DC voltage ^[1]	400 V	0.1 V	0.5% + 3	1000 V _{rms}
	1000 V	1.0 V	0.5% + 3	
Resistance ^{[2][4][5][8]}	400 Ω	0.1 Ω	0.5% + 3	0.8 mA
	4 k Ω	0.001 k Ω	0.5% + 2	80 μ A
Diode/Continuity ^{[2][3][6]}	Diode	0.001 V	0.5% + 2	0.8 mA
Capacitance ^[7]	400 μ F	0.1 μ F	2.0 % + 4	1000 V _{rms}
	4000 μ F	1.0 μ F	3.0% + 4	

^[1] Input impedance: 10 M Ω (nominal).

^[2] Overload protection: 1000 V_{rms} for circuits < 0.3 A of short circuit current.

^[3] Maximum open voltage: < +3.1 V.

^[4] Instant continuity: built-in beeper will sound when resistance is less than 10 Ω .

^[5] The accuracy of 400 Ω and 4 k Ω is specified after relative function, which is used to substrate the test lead resistance and the thermal effect.

^[6] Built-in beeper will sound when reading is below approximately 50 mV. Also, single-tone beeping for normal forward-biased diode or semiconductor junction with bias voltage between 0.3 V and 0.8 V.

^[7] With film capacitor or better, use null operation to zero out residual.

^[8] Use the null operation to zero out residual offset before measuring the signal (by shorting the test leads).

AC specifications

The AC voltage and AC current specifications are true RMS AC coupled, valid from 5% to 100% of range. The crest factor may be up to 3 at full scale, except for the 1000 V and 1000 A ranges which is 1.5 at full scale. For non-sinusoidal waveforms with crest factor ≤ 3 , add 2% reading + 2% full scale typical.

Table 7-3 U1211A AC accuracy \pm (% of reading + number of LSD)

Function	Range	Resolution	Accuracy	Overload protection
			45 Hz to 400 Hz	
AC voltage ^[1]	400 V	0.1 V	1.0% + 5	1000 V _{rms}
	1000 V	1 V	1.0% + 5	

Function	Range	Resolution	Accuracy ^{[3][4]}		
			45 Hz to 65 Hz	65 Hz to 400 Hz	400 Hz to 1 kHz
AC current ^[2]	40 A	0.01 A	1.0% + 10	1.0% + 10	3.0% + 10
	400 A	0.1 A	1.0% + 5	1.0% + 5	3.0% + 5
	400 A to 700 A	1 A	1.0% + 5	1.0% + 5	3.0% + 5
	700 A to 1000 A	1 A	1.0% + 5	–	–

^[1] Input impedance: 10 M Ω (nominal) in parallel with < 100 pF.

^[2] Maximum overload: 1000 A_{rms}

^[3] The accuracy for AC is specified on the symmetrical waveforms.

^[4] The maximum verification of current and frequency product is less than 400,000 A \times Hz.

7 Characteristics and Specifications

U1211A Electrical Specifications

Voltage 1 ms peak hold specifications

Table 7-4 U1211A voltage 1 ms peak hold specifications

Range	Resolution	Accuracy ^[1]	Overload protection
400 V	0.1 V	1.0% + 43	1000 V _{rms}
1000 V	1 V	1.0% + 43	

^[1] Specified accuracy for changes is > 1 ms in duration. Use the null operation to zero out residual offset before measuring the signal.

Current 1 ms peak hold specifications

Table 7-5 U1211A current 1ms peak hold specifications

Range	Resolution	Accuracy ^[1]	Maximum overload
40 A	0.01 A	2.0% + 70	1000 A _{rms}
400 A	0.1 A	2.0% + 43	
1000 A	1 A	2.0% + 43	

^[1] Specified accuracy for changes is > 1 ms in duration. Use the null operation to zero out residual offset before measuring the signal.

Frequency specifications

Table 7-6 U1211A frequency accuracy specifications \pm (% of reading + number of LSD)

Function	Range	Resolution	Accuracy	Minimum frequency ^[1]
Frequency	99.99 Hz	0.01 Hz	0.2% + 3	10 Hz
	999.9 Hz	0.1 Hz		
	9.999 kHz	0.001 kHz		
	99.99 kHz	0.01 kHz		
	999.9 kHz	0.1 kHz		

^[1] The input signal is lower than the product of 20,000,000 V \times Hz (product of voltage and frequency); overload protection: 1000 V.

Frequency sensitivity

Table 7-7 U1211A frequency sensitivity during voltage and current measurement

Range	Minimum sensitivity (rms)	
	40 Hz to 2 kHz	10 Hz to 40 Hz or 2 kHz to 100 kHz
Maximum input for specified accuracy of AC		
400 V	20 V	30 V (< 100 kHz)
1000 V	50 V	50 V (< 10 kHz)
40 A	3 A (< 1 kHz)	3 A (< 1 kHz)
400 A	20 A (< 1 kHz)	20 A (< 1 kHz)
1000 A	50 A (1 kHz)	50 A (< 1 kHz)

7 Characteristics and Specifications

U1211A Electrical Specifications

Operating specifications

Table 7-8 U1211A measuring rate

Function	Times/second
AC voltage	7
DC voltage	7
Resistance	14
Diode	14
Capacitance	4 (< 100 μ F)
AC current	7
Frequency	1 (> 10 Hz)

U1212A Electrical Specifications

The accuracy is given as \pm (% of reading + number of least significant digit) at 23 °C \pm 5 °C, with relative humidity less than 80% R.H.

DC specifications

Table 7-9 U1212A DC accuracy \pm (% of reading + number of LSD)

Function	Range	Resolution	Accuracy	Test current or burden voltage
DC voltage ^[1]	400 V	0.1 V	0.5% + 3	1000 V _{rms}
	1000 V	1 V	0.5% + 3	
DC current ^[2]	40 A	0.01 A	1.5% + 15	1000 A _{rms}
	400 A	0.1 A	1.5% + 5	
	1000 A	1 A	2% + 5	
Resistance ^{[3][4][5][6][9]}	400 Ω	0.1 Ω	0.5% + 3	0.8 mA
	4 k Ω	0.001 k Ω	0.5% + 3	80 μ A
Diode/Continuity ^{[3][4][7]}	Diode	0.001 V	0.5% + 2	0.8 mA
Capacitance ^{[3][8]}	400 μ F	0.1 μ F	2.0% + 4	1000 V _{rms}
	4000 μ F	1 μ F	3.0% + 4	

^[1] Input impedance: 10 M Ω (nominal).

^[2] Use the null operation to zero out residual offset before measuring the signal.

^[3] Overload protection: 1000 V_{rms} for circuits < 0.3 A of short circuit current.

^[4] Maximum open voltage: < +3.1 V.

^[5] Instant continuity: built-in beeper will sound when resistance is less than 10 Ω .

7 Characteristics and Specifications

U1212A Electrical Specifications

- [6] The accuracy of 400 Ω and 4 k Ω is specified after the null operation, which is used to substrate the test lead resistance and the thermal effect.
- [7] Built-in beeper will sound when reading is below approximately 50 mV. Also, single-tone beeping for normal forward-biased diode or semiconductor junction with bias voltage between 0.3 V and 0.8 V.
- [8] With film capacitor or better, use null operation to zero out residual.
- [9] Use the null operation to zero out residual offset before measuring the signal (by shorting the test leads).

AC specifications

The AC voltage and AC current specifications are true RMS AC coupled, valid from 5% to 100% of range. The crest factor may be up to 3 at full scale, except for the 1000 V and 1000 A ranges which is 1.5 at full scale. For non-sinusoidal waveforms with crest factor ≤ 3 , add 2% reading + 2% full scale typical.

Table 7-10 U1212A AC accuracy \pm (% of reading + number of LSD)

Function	Range	Resolution	Accuracy	Overload protection
			45 Hz to 400 Hz	
AC voltage ^[1]	400 V	0.1 V	1.0% + 5	1000 V _{rms}
	1000 V	1 V	1.0% + 5	

Function	Range	Resolution	Accuracy		Overload protection
			45 Hz to 65 Hz	65 Hz to 1 kHz	
AC current ^[2]	40 A	0.01 A	2.0% + 10	3.0% + 10	1000 V _{rms}
	400 A	0.1 A	2.0% + 5	3.0% + 5	
	1000 A	1 A	2.5% + 5	3.0% + 5	

^[1] Input impedance: 10 M Ω (nominal) in parallel with < 100 pF.

^[2] The maximum verification of current and frequency product is less than 400,000 A \times Hz.

7 Characteristics and Specifications

U1212A Electrical Specifications

Voltage 1 ms peak hold specifications

Table 7-11 U1212A voltage 1 ms peak hold specifications

Range	Resolution	Accuracy ^[1]	Overload protection
400 V	0.1 V	1.0% + 43	1000 V _{rms}
1000 V	1 V	1.0% + 43	

^[1] Specified accuracy for changes is > 1 ms in duration. Use the null operation to zero out residual offset before measuring the signal.

Current 1 ms peak hold specifications

Table 7-12 U1212A current 1 ms peak hold specifications

Range	Resolution	Accuracy ^[1]	Overload protection
40 A	0.01 A	2.0% + 70	1000 A _{rms}
400 A	0.1 A	2.0% + 43	
1000 A	1 A	2.0% + 43	

^[1] Specified accuracy for changes is > 1 ms in duration. Use the null operation to zero out residual offset before measuring the signal.

Temperature specifications

When measuring temperature, keep the thermocouple probe as close to the meter as possible, and avoid contact with surface above 30 V_{rms} or 60 V_{DC} as this will pose shock hazard.

Table 7-13 U1212A temperature specifications

Function	Thermocouple type	Range	Resolution	Accuracy ^[1]
Temperature ^[2]	K	-200 °C to -40 °C	0.1 °C	1.0% + 3 °C
		-40 °C to 1372 °C	0.1 °C	1.0% + 1 °C
		-328 °F to -40 °F	0.1 °F	1.0% + 6 °F
		-40 °F to 2502 °F	0.1 °F	1.0% + 2 °F

^[1] The accuracy does not include the tolerance of the thermocouple probe. The thermal sensor plugged into the meter should be placed in the operating environment for at least 1 hour prior to measurement.

^[2] The temperature calculation is based on the EN/IEC-60548-1 and NIST175 standards.

7 Characteristics and Specifications

U1212A Electrical Specifications

Frequency specifications

Table 7-14 U1212A frequency accuracy specifications \pm (% of reading + number of LSD)

Function	Range	Resolution	Accuracy	Minimum frequency ^[1]
Frequency (AC coupling)	99.99 Hz	0.01 Hz	0.2% + 3	10 Hz
	999.9 Hz	0.1 Hz		
	9.999 kHz	0.001 kHz		
	99.99 kHz	0.01 kHz		
	999.9 kHz	0.1 kHz		

^[1] The input signal is lower than the product of 20,000,000 V \times Hz (product of voltage and frequency);
overload protection: 1000 V.

Frequency sensitivity

Table 7-15 U1212A frequency sensitivity during voltage and current measurement

Range	Minimum sensitivity (rms)	
	40 Hz to 2 kHz	10 Hz to 40 Hz or 2 kHz to 100 kHz
Maximum input for specified accuracy of AC		
400 V	20 V	30 V (< 100 kHz)
1000 V	50 V	50 V (< 10 kHz)
40 A	3 A (< 1 kHz)	3 A (< 1 kHz)
400 A	20 A (< 1 kHz)	20 A (< 1 kHz)
1000 A	50 A (< 1 kHz)	50 A (< 1 kHz)

Operations specifications

Table 7-16 U1212A measuring rate

Function	Time/second
AC voltage	7
DC voltage	7
Resistance	14
Diode	14
Capacitance	4 (< 100 μ F)
DC current	7
AC current	7
Temperature	7
Frequency	1 (> 10 Hz)

7 Characteristics and Specifications

U1213A Electrical Specifications

U1213A Electrical Specifications

The accuracy is given as \pm (% of reading + number of least significant digit) at 23 °C \pm 5 °C, with relative humidity less than 80% R.H.

DC specifications

Table 7-17 U1213A DC accuracy \pm (% of reading + number of LSD)

Function	Range	Resolution	Accuracy	Test current or burden voltage
DC voltage ^[1]	4 V	0.001 V	0.2% + 3	1000 V _{rms}
	40 V	0.01 V		
	400 V	0.1 V	0.5% + 3	
	1000 V	1 V		
DC current ^[2]	40 A	0.01 A	1.5% + 15	1000 A _{rms}
	400 A	0.1 A	1.5% + 5	
	1000 A	1 A	2.0% + 5	
Resistance ^{[3][4][5][6][9]}	400 Ω	0.1 Ω	0.3% + 3	0.8 mA
	4 k Ω	0.001 k Ω		80 μ A
	40 k Ω	0.01 k Ω		8 μ A
	400 k Ω	0.1 k Ω		727 nA
	4 M Ω	0.001 M Ω	0.6% + 3	112 nA
	40 M Ω	0.01 M Ω	2.0% + 5	112 nA
Diode/Continuity ^{[3][7]}	Diode	0.001 V	0.5% + 2	0.8 mA

Table 7-17 U1213A DC accuracy \pm (% of reading + number of LSD) (continued)

Function	Range	Resolution	Accuracy	Test current or burden voltage
Capacitance ^{[3][8]}	4 μ F	0.001 μ F	1.0% + 4	1000 V _{rms}
	40 μ F	0.01 μ F	1.0% + 4	
	400 μ F	0.1 μ F	2.0% + 4	
	4000 μ F	1 μ F	3.0% + 4	

^[1] Input impedance: 10 M Ω (nominal).

^[2] Use the NULL function to zero out residual offset before measuring the signal.

^[3] Overload protection: 1000 V_{rms} for circuits < 0.3 A of short circuit current.

^[4] Maximum open voltage: < +3.1 V.

^[5] Instant continuity: built-in beeper will sound when resistance is less than 10 Ω .

^[6] The accuracy of 400 Ω and 4 k Ω is specified after the null operation, which is used to substrate the test lead resistance and the thermal effect.

^[7] Built-in beeper will sound when reading is below approximately 50 mV. Also, single-tone beeping for normal forward-biased diode or semiconductor junction with bias voltage between 0.3 V and 0.8 V.

^[8] With film capacitor or better, use null operation to zero out residual.

^[9] Use the null operation to zero out residual offset before measuring the signal (by shorting the test leads).

7 Characteristics and Specifications

U1213A Electrical Specifications

AC specifications

The AC voltage and AC current specifications are true RMS AC coupled, valid from 5% to 100% of range. The crest factor may be up to 3 at full scale, except for the 1000 V and 1000 A ranges which is 1.5 at full scale. For non-sinusoidal waveforms with crest factor ≤ 3 , add 2% reading + 2% full scale typical.

Table 7-18 U1213A AC accuracy \pm (% of reading + number of LSD)

Function	Range	Resolution	Accuracy		Overload protection
			45 Hz to 400 Hz	400 Hz to 2 kHz	
AC voltage ^[1]	4 V	0.001 V	1.0% + 5	2.0% + 5	1000 V _{rms}
	40 V	0.01 V			
	400 V	0.1 V			
	1000 V	1 V			

Function	Range	Resolution	Accuracy	
			45 Hz to 65 Hz	65 Hz to 1 kHz
AC current ^[2]	40 A	0.01 A	2.0% + 10	3.0% + 10
	400 A	0.1 A	2.0% + 5	3.0% + 5
	1000 A	1 A	2.5% + 5	3.0% + 5

^[1] Input impedance: 10 M Ω (nominal) in parallel with < 100 pF.

^[2] The maximum verification of current and frequency product is less than 400,000 A \times Hz.

AC + DC specifications

AC + DC voltage specifications

Table 7-19 U1213A AC + DC voltage accuracy \pm (% of reading + number of LSD)

Function	Range	Resolution	Accuracy		Overload protection
			45 Hz to 400 Hz	400 Hz to 2 kHz	
AC + DC voltage ^[1]	4 V	0.001 V	1.5% + 9	2.5% + 9	1000 V _{rms}
	40 V	0.01 V			
	400 V	0.1 V			
	1000 V	1 V			

^[1] Input impedance: 10 M Ω (nominal) in parallel with < 100 pF.

AC + DC current specifications

Table 7-20 U1213A AC + DC current accuracy \pm (% of reading + number of LSD)

Function	Range	Resolution	Accuracy ^[1]		Maximum overload
			45 Hz to 65 Hz	65 Hz to 1 kHz	
AC + DC current	40 A	0.01 A	3.5% + 25	4.5% + 25	1000 A _{rms}
	400 A	0.1 A	3.5% + 9	4.5% + 9	
	1000 A	1 A	4.5% + 9	5.0% + 9	

^[1] Use the null operation to zero out residual offset before measuring the signal.

7 Characteristics and Specifications

U1213A Electrical Specifications

Voltage 1 ms peak hold specifications

Table 7-21 U1213A voltage 1 ms peak hold specifications

Range	Resolution	Accuracy ^[1]	Overload protection
4 V	0.001 V	1.0% + 43	1000 V _{rms}
40 V	0.01 V		
400 V	0.1 V		
1000 V	1 V		

^[1] Specified accuracy for changes is > 1 ms in duration. Use the null operation to zero out residual offset before measuring the signal.

Current 1 ms peak hold specifications

Table 7-22 U1213A current 1 ms peak hold specifications

Range	Resolution	Accuracy ^[1]	Overload protection
40 A	0.01 A	2.0% + 70	1000 A _{rms}
400 A	0.1 A	2.0% + 43	1000 A _{rms}
1000 A	1 A	2.0% + 43	1000 A _{rms}

^[1] Specified accuracy for changes is > 1 ms in duration. Use the null operation to zero out residual offset before measuring the signal.

Temperature specifications

When measuring temperature, keep the thermocouple probe as close to the meter as possible, and avoid contact with surface above 30 V_{rms} or 60 V_{DC} as this will pose shock hazard.

Table 7-23 U1213A temperature specifications

Function	Thermocouple type	Range	Resolution	Accuracy ^[1]
Temperature ^[2]	K	-200 °C to -40 °C	0.1 °C	1.0% + 3 °C
		-40 °C to 1372 °C	0.1 °C	1.0% + 1 °C
		-328 °F to -40 °F	0.1 °F	1.0% + 6 °F
		-40 °F to 2502 °F	0.1 °F	1.0% + 2 °F

^[1] The accuracy does not include the tolerance of the thermocouple probe. The thermal sensor plugged into the meter should be placed in the operating environment for at least 1 hour prior to measurement.

^[2] The temperature calculation is based on the EN/IEC-60548-1 and NIST175 standards.

7 Characteristics and Specifications

U1213A Electrical Specifications

Frequency specifications

Table 7-24 U1213A frequency accuracy specifications \pm (% of reading + number of LSD)

Function	Range	Resolution	Accuracy	Minimum frequency ^[1]
Frequency	99.99 Hz	0.01 Hz	0.2% + 3	10 Hz
	999.9 Hz	0.1 Hz		
	9.999 kHz	0.001 kHz		
	99.99 kHz	0.01 kHz		
	999.9 kHz	0.1 kHz		

^[1] The input signal is lower than the product of 20,000,000 V \times Hz (product of voltage and frequency); overload protection: 1000 V.

Frequency sensitivity

Table 7-25 U1213A frequency sensitivity during voltage and current measurement

Range	Minimum sensitivity (rms)	
	40 Hz to 2 kHz	10 Hz to 200 kHz
Maximum input for specified accuracy of AC		
4 V	0.3 V	0.6 V
40 V	2 V	3 V
400 V	20 V	30 V (< 100 kHz)
1000 V	50 V	50 V (< 10 kHz)
40 A	3 A (< 1 kHz)	3 A (< 1 kHz)
400 A	20 A (< 1 kHz)	20 A (< 1 kHz)
1000 A	50 A (< 1 kHz)	50 A (< 1 kHz)

Duty cycle

Table 7-26 U1213A duty cycle accuracy specification

Mode	Range	Accuracy of full scale ^[1]
AC coupling	0.1% to 99.9%	0.3% per kHz + 0.3%

^[1] The accuracy for duty cycle is based on a 4 V square wave input to the DC 4 V range and maximum frequency of up to 2 kHz. The duty cycle range can be measured within the range of 5% to 95% for signal frequency > 20 Hz.

Operations specifications

Table 7-27 U1213A measuring rate

Function	Time/second
AC voltage	7
DC voltage	7
Resistance	14
Diode	14
Capacitance	4 (< 100 μ F)
DC current	7
AC current	7
Temperature	7
Frequency	1 (> 10 Hz)
Duty cycle	0.5 (> 10 Hz)

7 Characteristics and Specifications

U1213A Electrical Specifications

www.agilent.com

Contact us

To obtain service, warranty or technical assistance, contact us at the following phone or fax numbers:

United States:

(tel) 800 829 4444 (fax) 800 829 4433

Canada:

(tel) 877 894 4414 (fax) 800 746 4866

China:

(tel) 800 810 0189 (fax) 800 820 2816

Europe:

(tel) 31 20 547 2111

Japan:

(tel) (81) 426 56 7832 (fax) (81) 426 56 7840

Korea:

(tel) (080) 769 0800 (fax) (080) 769 0900

Latin America:

(tel) (305) 269 7500

Taiwan:

(tel) 0800 047 866 (fax) 0800 286 331

Other Asia Pacific Countries:

(tel) (65) 6375 8100 (fax) (65) 6755 0042

Product specifications and descriptions in this document are subject to change without notice. Always refer to Agilent Web site for the latest revision.

© Agilent Technologies, Inc., 2009–2013

Eighth Edition, May 23, 2013
U1211-90001



Agilent Technologies